



Moving forward with concrete results

Concrete Pavement Joint Design, Layout and Construction

August 18, 2020

Kevin W. McMullen, P.E.
President

Wisconsin Concrete Pavement Association



What are we going to cover?

- Fundamentals of why we joint concrete
- Joint Spacing
- When do we saw?
- How deep do we saw?
- Types of Joints
- Joint Sealing
- Load Transfer
- Transverse Construction Joints



Why Joint Concrete Pavements?



Concrete Shrinks!

Hydration Uses Water



Drying Shrinkage

Hot then Cold

HOT AT SET

COOLED OFF

Thermal Shrinkage

$$\Delta L = \alpha * \Delta T * L$$

Chemical Shrinkage

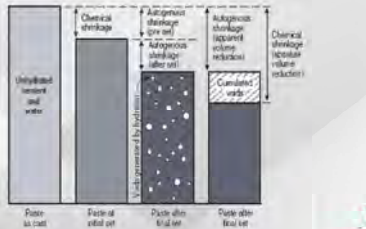

Shrinkage + Restraint = CRACKS!?!

HOT AT SET, HIGH MOISTURE, UNHYDRATED CEMENT

If no restraint

COOL, DRY, HYDRATED CEMENT

TEFLON | No Friction/Restraint

With restraint

Subgrade/Subbase | Restraint



Why Joint Concrete Pavement?

- Without joints, natural transverse & longitudinal cracking would form about like this...

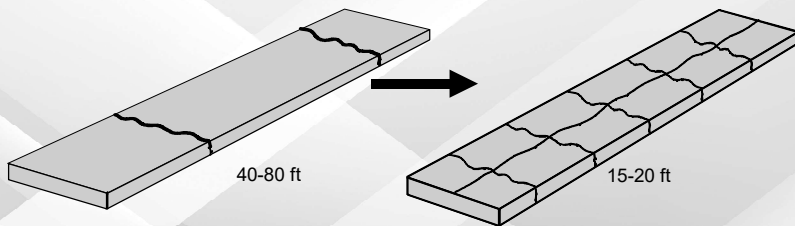

Why Joint Concrete Pavement?

- We place joints at a slightly shorter spacing to prevent natural cracking...

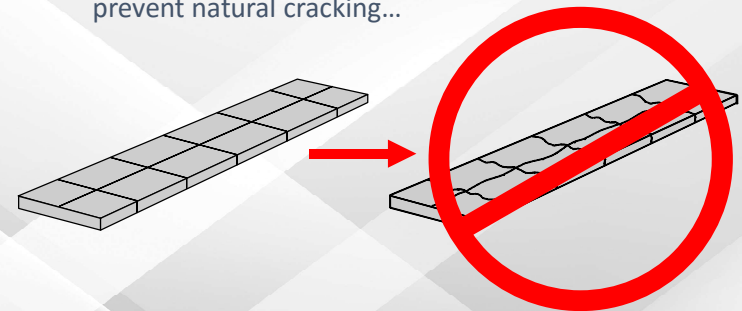

Why Joint Concrete Pavement?

- Other reasons we joint concrete pavements:

- Help the traffic engineers define lanes
- Divide pavement into construction lanes or increments.
- Accommodate slab movements.
- Provide load transfer via placed dowels.
- Provide uniform sealant reservoir.



TYPES OF JOINTS



Types of Joints

- Joint types:
 - Contraction
 - Construction
 - Isolation (and, if necessary, expansion)
- Each can occur in either the transverse or longitudinal directions.
- Also specialty joints (e.g., transitions, terminal joints in continuously reinforced, etc.).



Types of Joints

Transverse Contraction:

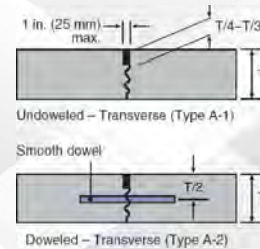

Types of Joints

Longitudinal Contraction:

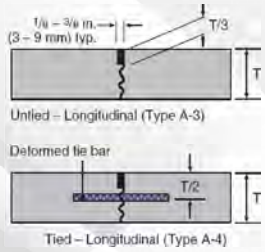

Types of Joints

Transverse Construction:

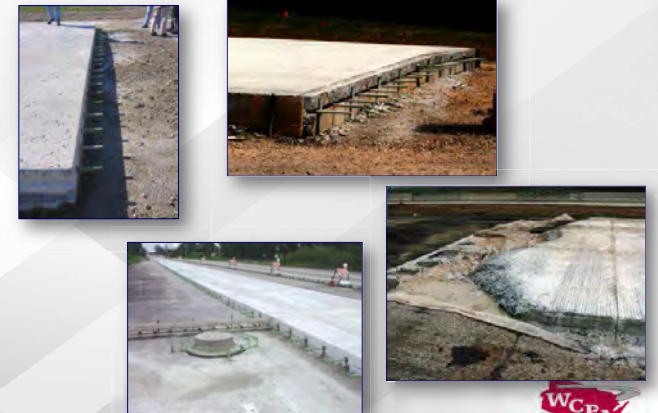
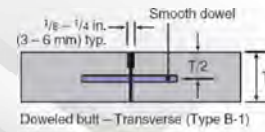

Types of Joints

Longitudinal Construction:

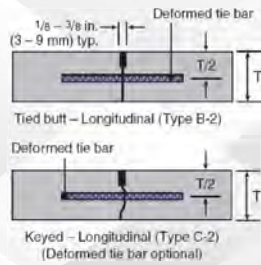

Types of Joints

Isolation:

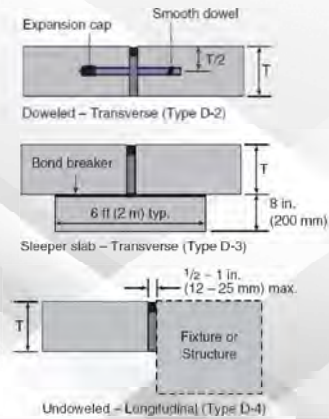

Examples of Locations



TB019P

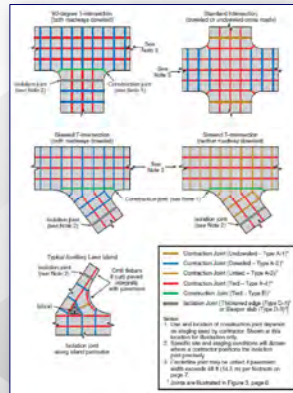
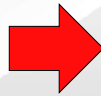

Joint Spacing



Joint Spacing

Evolution



JOINT SPACING

- 2 x T (Granular Sub-base)
- 1.5 x T (Stabilized Sub-base)
- Experience



Formula for Maximum Joint Spacing

MECHANISTIC

$$l = \sqrt[4]{\frac{Eh^3}{12(1-\mu^2)k}}$$

l = radius of relative stiffness, in.
 E = modulus of elasticity of the concrete, psi
 h = slab thickness, in.
 k = modulus of subgrade reaction, psi/in.
 μ = Poisson's ratio for concrete, usually 0.15

L/l of 7 works in field; LIMIT L/l to about 4-5 to be conservative



Example with Radius of Rel. Stiffness

E = 4 x 10⁶ psi
 h = 8 in.
 k = 100 psi/in.
 μ = 0.15

$$l = \sqrt[4]{\frac{Eh^3}{12(1-\mu^2)k}}$$

$$l = \sqrt[4]{\frac{4 \times 10^6 * 8^3}{12 * (1 - 0.15^2) * 100}}$$

l = 36.35 in.

Slab Length is 4 or 5 time this:

L = 4 * l = 4 * 36.35 in. = 12.1 ft
 L = 5 * l = 5 * 36.35 in. = 15.1 ft

But there is an easier way...



Example with Radius of Rel. Stiffness

E = 4 x 10⁶ psi
 h = 8 in.
k = 300 psi/in.
 μ = 0.15

$$l = \sqrt[4]{\frac{Eh^3}{12(1-\mu^2)k}}$$

$$l = \sqrt[4]{\frac{4 \times 10^6 * 8^3}{12 * (1 - 0.15^2) * 300}}$$

l = 27.62 in.

Slab Length is 4 or 5 time this:

L = 4 * l = 4 * 27.62 in. = 9.2 ft
 L = 5 * l = 5 * 27.62 in. = 11.5 ft

But there is an easier way...



Formula for Maximum Joint Spacing

EMPIRICAL

$$ML = T \times C_s$$

ML = Maximum length between joints (in. or cm)

T = Slab thickness (in. or cm)

C_s = Support constant

- Use 24 for subgrades or unstabilized [granular] subbases;
- Use 21 for stabilized subbases (ATB, CTB, lean concrete) or existing concrete or asphalt pavement;
- Use 12 to 15 for thin bonded overlays on asphalt

If based on thickness, is this considered in thickness design?



Effects of Joint Spacing

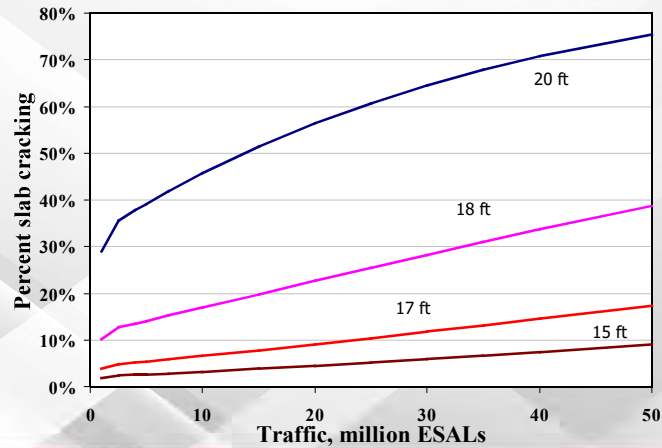

Coefficient of Thermal Expansion

Other Consideration: Concrete Aggregate

Limestone

Siliceous Gravel

Temperature Sensitivity



Other Joint Spacing Issues

- Random? Don't Do it!!!!
 - Old concept
 - Suspensions of vehicles has changed
- Skew? Don't Do It!!
 - Diagonal effect
 - An effort to prevent faulting in undoweled joints
 - Typical was 1:6 skew
 - Just delayed the onset of faulting



Joint Spacing Recommendations

For Streets, Roads, and Highways:

- Use $ML = T \times C_s$
- Keep ratio of transverse to longitudinal spacing at less than 1.5; ***square is best***
- Keep maximum spacing of transverse joints to 15 ft (4.57 m) for plain concrete unless local history shows longer panels work (e.g., low CTE aggregate)



How deep do we saw?



Joint Depth Recommendations

- Transverse
 - T/4 on unstabilized
 - T/3 on stabilized
- Longitudinal
 - T/3
- Timing is a factor
- Early-entry sawing may allow for sawing depths of T/6 to T/5, but at least 1.25 in. (32 mm) deep
 - If start to see dust from cut, consider reverting to a cut depth of T/4

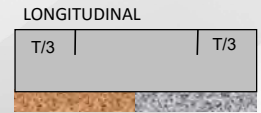

Proper Location, Time & Depth = Joint Activated Over Dowel Bars



Load Transfer



Dowels: Critical Structural Components of Jointed Concrete Pavement

- Provide Load Transfer
 - Prevent joint faulting
 - Reduce slab stresses
 - Reduce slab deflections, potential for erosion of support
- Restraint of Curl/Warp Deformation
- Influence Dowel-Concrete Bearing Stress, Faulting
- Dowel corrosion can cause joint spalling, joint lock-up and associated distresses



WisDOT Dowel Bars

- Dowel bars
 - 18-inches in length
 - Spaced 12-inches center to center across the transverse joint
 - Diameter usually ranges from 1-inch to 1.5-inches depending on the slab thickness

PAVEMENT DEPTH, DOWEL BAR SIZE AND JOINT SPACING TABLE

PAVEMENT DEPTH (D)	DOWEL BAR DIAMETER	CONTRACTION JOINT SPACING
5 1/2", 6", 6 1/2"	NONE	12'
7", 7 1/2"	1"	14'
8", 8 1/2"	1 1/4"	15'
9", 9 1/2"	1 1/4"	15'
10" & ABOVE	1 1/2"	15'



WisDOT Dowel Bar Baskets

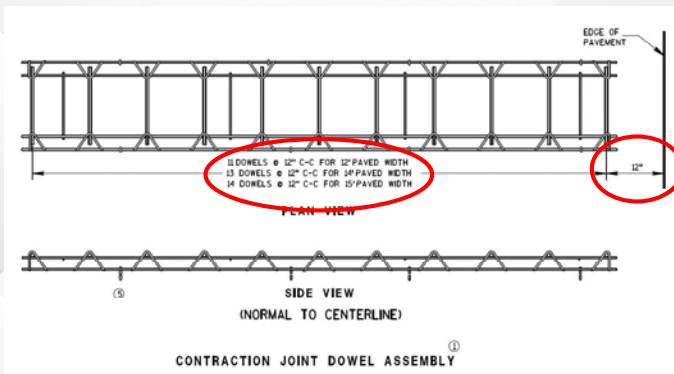

Dowel Bar Baskets

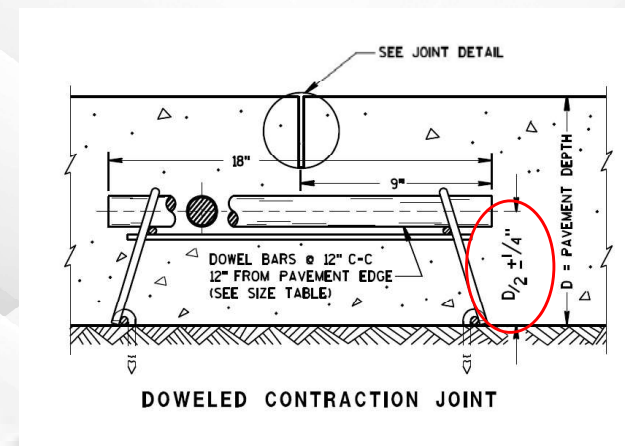

Dowel Bar Tolerances

- Dowel bar position and alignment are critical
- Dowel misalignment
 - Significant effect on pavement performance resulting in cracking
- Dowel bar alignment tolerance
 - ¼ -inch/foot or less in the vertical and horizontal plane
- Common misalignment specifications:
 - Within 1 inch of the planned transverse location and depth
 - Within 2 inches of the planned longitudinal location.
 - Parallel to the pavement surface and centerline within a tolerance of 1/2 inches in 18 inches.
- This tolerance allows for whole inch baskets to be used for half-inch pavement thicknesses (Example: 9-inch basket used in a 9.5-inch pavement)

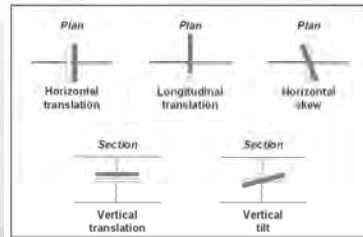

Baskets or DBI

- DOWEL BAR INSERTER (DBI)
- Research shows inserters can be just as accurate or more so than baskets
- Research also shows that baskets can be placed as inaccurate as inserters too.
- Both methods have their place and advantage



Dowel Length

- Typically 18 in (since 1950s)
- Based on embedment requirements to match behavior of Timoshenko 1925 analysis (semi-infinite embedded bar)
- A few states successfully use shorter dowels in new construction (e.g., 15 inches in MN)
- Shorter embedment lengths are supported by research dating to 1950s



DowelCAD 2.0

- **FREE** software that predicts pavement behaviors based on different round and elliptical dowel bar spacings and configurations.
- Results can help designers significantly decrease embedded steel content (and costs) without compromising performance!
- Program based on finite element analyses.

WWW.APPS.ACPA.ORG

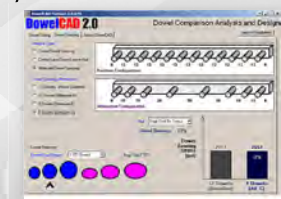

Dowel Bar Options



High Performance Concrete PAvement Dowel Bars

- 316L Stainless Steel Cladding
- 316L Stainless Steel Tubes
- Solid Stainless Steel
- UNS Z41121 Zinc Alloy Cladding
- CRT Bar – Conventional steel with fiber composite outer coating
- Armour Coat Solid Dowel Bar – Simplex
- G90 Galvanized O-Dowel Tube



HPC Dowel Bars



HPC Dowel Bars G90 Galvanized O-Dowel Tube



HPC Dowel Bars

Armour Coat Solid Dowel Bar – Simplex



New O-Dowel by Schenk Industrial

- Lightweight tubular steel
- 11 gauge
- Welded flat rolled carbon steel tubular
- G40 Galvanized coating
- Standard epoxy coating
- “One man dowel basket”



Tie Bars



Tie Bar Design Concepts

- Purpose: hold longitudinal joints tight
- Design tools
 - 1986/1993 AASHTO Guide
 - ACPA M-E Tie Bar Design (apps.acpa.org)
- Generally oversized
 - Too much steel! We are often reinforcing the joints (counteracting saw cuts) rather than tying them!
 - Note German practice: 2 ties per 15-ft panel for new construction
 - Tie bar length is typically selected to develop full tensile capacity of the bar rather than required tensile capacity
- Bearing stress (selection of bar size) can be important for butt joints



Tie Bar Design – Subgrade Drag Theory



Force in Steel = Force in Concrete

$$A_s = FLhdw / [f_s \times (2/3)]$$

- A_s = area of steel per lineal foot (in²)
- f_s = allowable working stress (lb/in²)
- F = coefficient of friction factor
- L = slab length (in.)
- D = distance to free edge (in.)
- h = slab thickness (in.)
- w = concrete unit weight (lb/in³)

PROBLEMS:

- Based on drag
- No temp drop from set
- Free edge does not apply after 2+ lanes
- Simplistic method of modeling slab/base friction
- Large safety factor (2/3)
- Does not account for displacement of subbase



Tie Bar Installation

- Commonly mechanically inserted when paving multiple lanes
- Tie bar baskets used as well
- Bent tie bars are used at longitudinal construction joints to accommodate future stages
- Verify longitudinal positioning:
 - Do not place tie bars across a transverse joint. The insertion of the tie bars may conflict with the insertion of the dowel bars causing the dowel bars to become misaligned



WisDOT Tie Bars

- Tie bars installed in new concrete are #4 or #5 deformed bar, 30 or 36 inches long spaced at 36-inches center to center depending on the pavement thickness
- Bent #4 deformed bars as noted

TIE BAR TABLE			
PAVEMENT DEPTH (D)	TIE BAR SIZE	TIE BAR LENGTH (L)	MAX. TIE BAR SPACING
< 30 1/2"	NO. 4	30"	36"
≥ 30 1/2"	NO. 5	36"	36"
	NO. 4*	30"	24**

* SUBSTITUTE BENT BARS AT LONGITUDINAL JOINTS WHEN EQUIPMENT LIMITATIONS DURING CONSTRUCTION WARRANT (e.g. AUXILIARY LANES OR TURN LANES)

** CONFORM TO 15" MINIMUM SPACING FROM TRANSVERSE JOINTS; SPACING BETWEEN TIE BARS WILL BE 30" AT TRANSVERSE JOINTS.

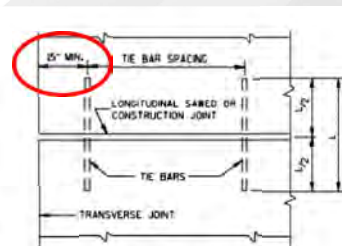

PLAN VIEW
SHOWING LOCATION OF TIE BARS



WisDOT Tie Bar Placement

- WisDOT Standard Detail Drawing (SDD).

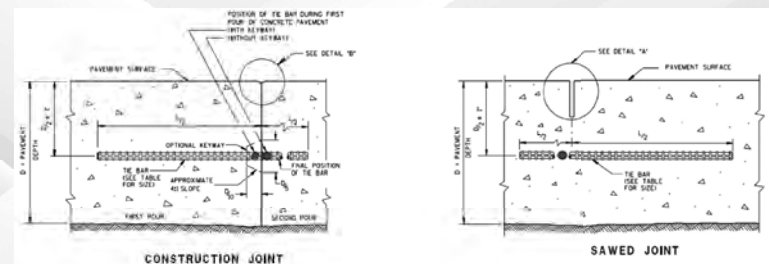

Transverse Construction Joints



Construction Joints (Headers)

- Header joints (also known as transverse construction joints) are built at the end of a section of pavement
 - Must be constructed at the end of a day's run
 - Constructed due to significant paving delays
- Either formed or sawed
- No way to account for in layout planning
- If next to previously placed pavement, best to match header with existing transverse joint



Formed Header

- Either two-part form with dowels protruding through form or false-dowels attached to form face and dowels inserted upon form removal; consolidate concrete well at form



Formed Header



Sawed Header

- Paving continued through of header, pavement sawed back, dowel/tiebar holes drilled, and dowels/tiebars installed



Joint "Sealing" or Joint "Filling"



Joint Sealants

History & Background

- Accepted definition:
Sealants minimize infiltration of surface water & incompressibles into the joint system.
- Erroneous definition:
Sealants prevent infiltration of surface water & incompressibles into the joint system.



Joint Filling Specs

- Joint performance issues
- Posted speeds and tire noise
- Curb and gutter confining debris on roadway
- Joints filling with incompressibles and spalling occurring
- Urban pavements less than 45 mph with curb and gutter

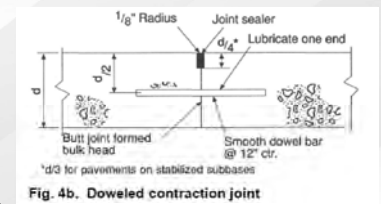

JOINT LAYOUT



Intersection Jointing

- Develop a jointing plan
 - Bird's eye view
- Follow ACPA's method
- Be practical!



ACPA Publication IS006 "Intersection Joint Layout"

- 10-step method
- Special situations
 - Added lanes
 - Islands
 - Skewed intersections
- Utility fixtures



The Challenge of the Intersection in 10 steps

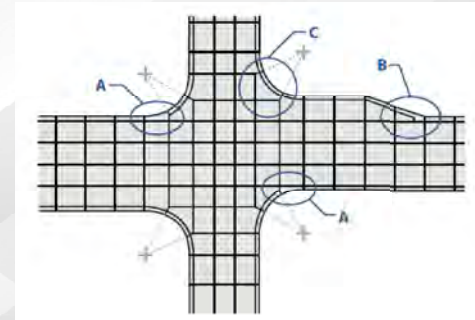
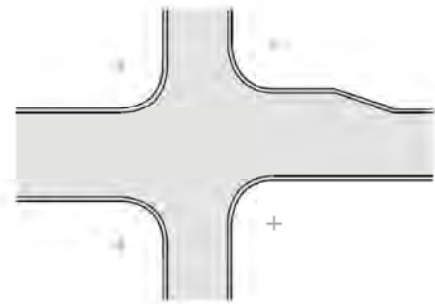

3 Easy Rules

- ✓ Keep it Short!
- ✓ Keep it Simple!
- ✓ Keep it Practical!



Things to Ensure

- Match existing joints or cracks
- Place Joints to meet in-pavement structures
- Error on the short side
- Exact spacing not important
- Consider non-obvious factors
 - Avoid acute angles
 - Meet pavement width changes
- Length to Width Ratio:
 - Target 1.25
 - Do Not exceed 1.5



Things to Avoid

- Slabs < 1 foot wide
- Slabs > 15 feet wide
- Angles < 60° (<90° is better)
- Interior corners (L-shaped slabs)
- Odd shapes (keep slabs square or pie-shaped)



In-Pavement Objects



Square Inlet (no boxout)

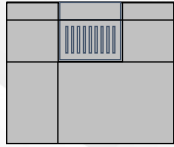

Round Inlet Boxout

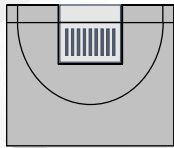

Square

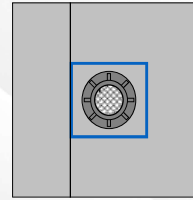

Diagonal

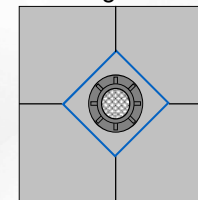

Isolate Perimeter

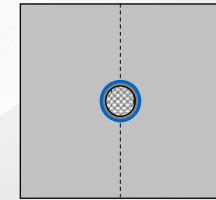

Square w/ Fillets

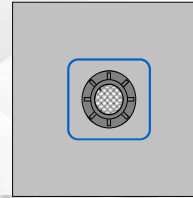

Circular

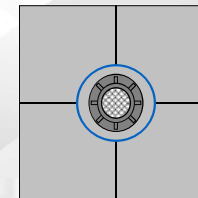

Telescoping

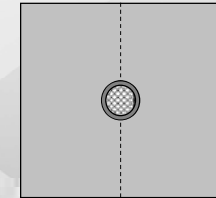

Good Practice!



THANK YOU and happy to follow up with any questions



Main Website | acpa.org
Free Apps | apps.acpa.org
Resources | resources.acpa.org
Your Local Contact | local.acpa.org



Kevin W. McMullen, P.E.
President

Wisconsin Concrete Pavement Association

kmcmullen@wisconcrete.org

(608)209-0878

www.wisconcrete.org

