



First Large Scale Demonstration Project

Electrically Conductive Concrete Heated Airport Pavement System at Des Moines International Airport: Design, Construction and Performance

**Presented by
Halil Ceylan, Ph.D.**

Dept. of Civil, Construction and Environmental Engineering (CCEE)

ISU Site Director for PEGASAS

Program for Sustainable Pavement Engineering and Research (PROSPER)

Institute for Transportation (InTrans), Iowa State University (ISU)

The 2017 Better Concrete Conference, November 9, 2017

Scheman Continuing Education Building, Iowa State University, Ames, Iowa



Acknowledgements

- FAA and PEGASAS
 - Peter L. Sparacino, P.E., former Program Manager (retired, formerly at FAA)
 - Ryan King, P.E., Program Manager (FAA)
 - Jeffrey S. Gagnon, P.E., (FAA)
 - Benjamin J. Mahaffay, P.E., TPOC (FAA)
 - Charles A. Ishee, Ph.D., P.E., former TPOC (formerly at FAA)
 - Donald Barbagallo, P.E., former TPOC (retired, formerly at FAA)
 - William A. Crossley, Ph.D., Director (PEGASAS, Purdue)
 - Richard Wlezien, Ph.D., former Co-Site Director (PEGASAS, ISU)
 - Julienne M. Krennrich, Ph.D., former Co-Site Director (PEGASAS, ISU)
 - Diane M. Meyer, (ERI, ISU)
- Iowa State University
- Purdue University



Acknowledgements: PEGASAS Industrial Advisory Board

- Randy Nelson, Chair (Full Nelson Consulting)
- Rod Borden, J.D. (Columbus Regional Airport Authority)
- Simon Caldecott (Piper)
- Travis Cottrell (Textron Aviation)
- Robbie Cowart (Gulfstream)
- Rick Crider (Kelly Field/Port San Antonio Airport Authority)
- John Frasca (Frasca International)
- Bill Hogate (Frasca International)
- Jens Henning (General Aviation Manufacturers Association)
- Scott Meacham (CAP Aviation Consulting Group)
- John Gausch (CAP Aviation Consulting Group)
- Kevin Ohrenberger (Sikorsky Aircraft Corp)
- Gloria Liu (Continental Motors)
- Robert (Bob) Tanner, J.D. (Net Jets)



Acknowledgements: Airports

- Des Moines International Airport, Des Moines, IA (DSM)
 - Bryan Belt, Mark Duffy, William Konkol, and others
- St. Paul International Airport, Minneapolis, MN (MSP)
 - Paul M. Sichko
- Port Columbus International Airport, Columbus, OH (CMH)
 - Joshua Burger
- Kent State University Airport, Kent, OH (1G3)
 - Dave Poluga
- Mason City Municipal Airport, Mason City, IA (MCW)
 - David Sims



Acknowledgements: Industry Partners

- American Concrete Pavement Association (ACPA)
 - Gary L. Mitchell, P.E., Vice President
- Asbury Carbons
- Central Iowa Ready Mix (Keith Kuennen)
- Foth infrastructure & environmental, LLC. (Adam Wilhelm)
- GCP Applied Technologies (Allen R. Johnson)
- Iowa Concrete Paving Association (Dan King)
- Kingston Services, LLC.
- Zoltek Companies, Inc.



Executive Summary: PEGASAS Project #1 Heated Airport Pavements

Lead Investigators: Halil Ceylan (PEGASAS Point of Contact) (Iowa State University) and John Haddock (Purdue University)

Maintaining operational safety and status of airport runways during snowfall events is a challenging issue that many airports are grappling with. The surface traction of pavement is dramatically influenced by frozen precipitation in the form of ice, snow, or slush. This can seriously hamper smooth air traffic management operations and cause traffic delays at other airports. It is imperative that both small and large airports maintain operational status during snowfall events to support the existing operations.

Over the past decade, a number of national and international research studies have investigated the use of alternative energy for anti-icing, deicing, and snow removal from bridge decks and highway pavements. Reportedly some efforts have been investigated using geothermal hydraulic and battery based electrical systems with limited success. The Federal Aviation Administration (FAA) has expressed an interest in investigating the concept of heating pavements at airports to assist with snow and ice removal, recognizing the limitations of current practice and research on heated pavement technology.

In this project we propose a eight-pronged approach including **Task 1-A: Energy and financial viability, Task 1-B: Hybrid heated airport pavements, Task 1-C: Phase change materials for concrete, Task 1-D: Advanced construction techniques, Task 1-E: Phase change materials for asphalt, Task 1-F: Electrically conductive asphalt concrete, Task 1-G: Superhydrophobic asphalt concrete, and Task 1-H: Full-scale demonstration.** The expected benefits of the project are:

- A better understanding of the relative costs of installing and running heated pavement systems with respect to the current systems, along with benefits to worker safety and operating efficiency to the airport,
- An approach to decision making regarding whether or not to install such a system, and selection of the systems that may be beneficial,
- Improved operational efficiency at airports, reduced costs and impacts of snow and ice removal,
- Expedited and efficient snow and ice removal operations that can reduce traffic delays, especially at large air-ports,
- An approach by not possessing any environmental concerns like the contamination of nearby bodies of water and foreign object debris/damage (FOD) to aircraft engines,
- Reduction of downtime required to clear ice and snow,
- Improve safety for ground crews servicing the aircraft at the gate area, improve safety of passengers embarking/disembarking the aircraft.

The overall impacts of this research will make winter air travel faster, more affordable, more accessible, more sustainable and safer for all parties involved.



Electrically conductive concrete (ECON)

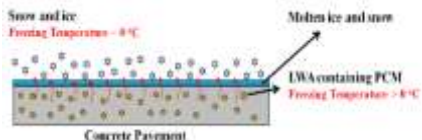

Des Moines International Airport
ECON Heated Pavement System



Superhydrophobic concrete

- Iowa State University (ISU)
 - Halil Ceylan, Ph.D., Lead PI & TPOC for PEGASAS Project no 1
 - Sunghwan Kim, Ph.D., P.E., Co-PI
 - Peter C. Taylor, Ph.D., P.E., Co-PI
 - Sriram Sundararajan, Ph.D., Co-PI
 - Kristen Sara Cetin, Ph.D., Co-PI
 - Bora Cetin, Ph.D., Co-PI
 - Mani Mina, Ph.D., Co-PI
 - Robert F. Steffes, PCC Lab Manager
 - Kasthurirangan (Rangan) Gopalakrishnan, Ph.D. (currently at Northwestern Univ.), Co-PI
 - Konstantina (Nadia) Gkritza, Ph.D. (currently at Purdue Univ.), Co-PI
 - Yelda Turkan, Ph.D. (currently at Oregon State Univ.), Co-PI

- Iowa State University (ISU)
 - 15 graduate student (9 Ph.D. & 6 MS/ME) researchers
 - Ali Arabzadeh (CCEE), Ph.D. student
 - Ali Nahvi (CCEE), Ph.D. student
 - Alireza Sassani (CCEE), Ph.D. student
 - Hesham Abdulla (CCEE), Ph.D. student
 - Sajed Sadati (CCEE), Ph.D. student
 - Shuo Yang (CCEE), Ph.D. student
 - Bo Yang (CCEE), Ph.D. student
 - Gowtham Sivakumar (ME), Ph.D. student
 - Wei Shen Theh (ECpE), Ph.D. student
 - Abdullah Abdullah (CCEE), M.S. student
 - Akash Vidyadharan (AERO), M.S. student (graduated in Spring 2017)
 - Therin Young (ME), M.S. student (graduated in Summer 2016)
 - Pritha Anand (CCEE), M.S. student (graduated in Fall 2015)
 - Weibin Shen (CCEE), M.S. student (graduated in Summer 2015)
 - Shivadarshini Palani Andy Ravindran (CCEE), M.E. student (graduated in Spring 2015)



Participants (Cont'd)

- Iowa State University (ISU)
 - 7 undergraduate student researchers
 - William O. Cord (CCEE), B.S. student (graduated in 2014)
 - Kailin Zhuan (CCEE), B.S. student (graduated in 2014)
 - Wei Yee Lim (CCEE), B.S. student (graduated in 2016)
 - Michelle Chew (CCEE), B.S. student (graduated in 2016)
 - Jordan Schlak (AERO), B.S. student (graduated in 2016)
 - Collin Smith (AERO), B.S. student
 - Colin Heinrichs (EcpE), B.S. student



- Motivation, Need and Objective(s)
- Approach, Methods and Design
- Construction and Performance Evaluation
- Summary

CNN U.S. Edition | News Video TV Opinions More... | New York City, NY 10° | Search CNN

U.S. World Politics Tech Health Entertainment Living Travel Money Sports

StarTech.com USB to DVI Adapter \$75.49 | StarTech.com SHOP CDW | StarTech.com CDW PEOPLE WHO GET IT

Delta flight skids off LaGuardia runway, stops feet from frigid waters

By Greg Botelho, CNN | Updated 8:44 PM ET, Thu March 5, 2015

Courtesy: CNN

Courtesy: Fox News

DELTA

FOX5 PLANE WAS ARRIVING FROM ATLANTA

BREAKING NEWS



Courtesy: ABC News

ON THE PHONE

Jared Faellaci

PASSENGER ON DELTA FLIGHT

1:14 20°

abc 7

Courtesy: NBC News

THOMAS ROBERTS 10:02 PM msnbc.com

BREAKING NEWS

PLANE SLIDES OFF RUNWAY AT LAGUARDIA

INTERNATIONAL NE BLAST RISES TO 32





Motivation (Cont'd)

Delta Airlines plane skids off JFK runway

Courtesy: NY Post

By Philip Messing, Priscilla DeGregory and David K. Li

January 5, 2014 | 9:16am



The Delta plane moments after is skidded off the runway at JFK.

A screenshot of a CNN news article. The top navigation bar includes "International Edition", "News", "Regions", "Video", "TV", "Features", "Opinions", and "More...". Below this are regional links: "U.S.", "China", "Asia", "Middle East", "Africa", "Europe", and "Americas". The article title is "NTSB: Pilot erred in runway crash that killed boy". The date is "October 2, 2007" and the update time is "Updated 11:29 AM EDT (0800 HKT)". The text of the article begins: "WASHINGTON (CNN) — Federal investigators Tuesday blamed the pilot of a Southwest Airlines jet for causing the plane to skid off a runway at Chicago's Midway Airport in 2005, an accident that killed a 6-year-old boy." To the right of the article is a "STORY HIGHLIGHTS" section with a bulleted list of key points. At the bottom right, there is a "We Recommend" section.

Courtesy: CNN



USA TODAY
A GANNETT COMPANY

NEWS SPORTS LIFE MONEY TECH TRAVEL OPINION 60° CROSSWORDS YOUR TAKE INVESTIGATIONS VIDEO STOCKS APPS MORE

Search

Flight cancellations spike Friday, near 8,000 for the week

TODAY IN THE SKY Ben Mutzabaugh, USA TODAY 7:13 p.m. EST February 27, 2015 Courtesy: USA Today

Nearly 8,000 flights have been cancelled because of the snow storm including some out of Houston. KHOU

KHOU Staff, KHOU.com 1:23 p.m. CST January 27, 2015 Courtesy: KHOU.com

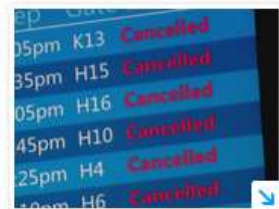

(Photo: KHOU)

CONNECT TWEET 4 LINKEDIN COMMENT EMAIL MORE

HOUSTON – About 60 million people are waking up to snow across the northeast but the blizzard predictions were not as severe as predicted.

Travel bans across several states are being lifted. There was still snow, but clearly not as much as expected.

Airlines cancelled nearly 8,000 flights, which impacted travelers flying in and out of Houston airports.

At George Bush Intercontinental Airport, many connecting flights across the country were affected.

UPDATE: Black Ice, Accidents, Speed Restrictions, Airport Delays As New Jersey Battles Storm Impact

Truck fell through ice in Toms River; a list of accidents that are causing delays on roads; three-hour delays at airports.

By Tom Davis (Patch Staff)
© March 2, 2015 at 6:27am Courtesy: patch.com

News

JFK Airport Runways Reopen Following Snow Squall

February 22, 2015 9:12 PM Courtesy: CBS News

Share 111 Tweet 50 View Comments

7:45a	Dubai	Emirates	EK 201	Arrived at	9:58a
7:45a	Dubai	Emirates	EK 201	New Time:	8:35a
1:50p	Dubai	Emirates	EK 201	On Time	
1:50p	Dubai	Emirates	EK 201		
5:48a	Newark Int'l	DELTA	DL 1162	New Time:	2:00p
7:00a	Newark Int'l	DELTA		New Time:	10:58a
10:44a	Fort Lauderdale	DELTA		New Time:	12:28p
11:55a	Fort Lauderdale	Emirates	VX 300		
1:20p	Georgetown	Continental	BW 824	New Time:	1:02p
1:20p	Georgetown	Continental	BW 824	New Time:	

AFTER THE STORM JFK Closure WHY 10 55

Airlines cancel flights as another snowstorm hits Northeast

Courtesy: USA Today

TODAY IN THE SKY Harriet Baskas, Special for USA TODAY 10:56 a.m. EST February 9, 2015

- Snow and ice hits airport!

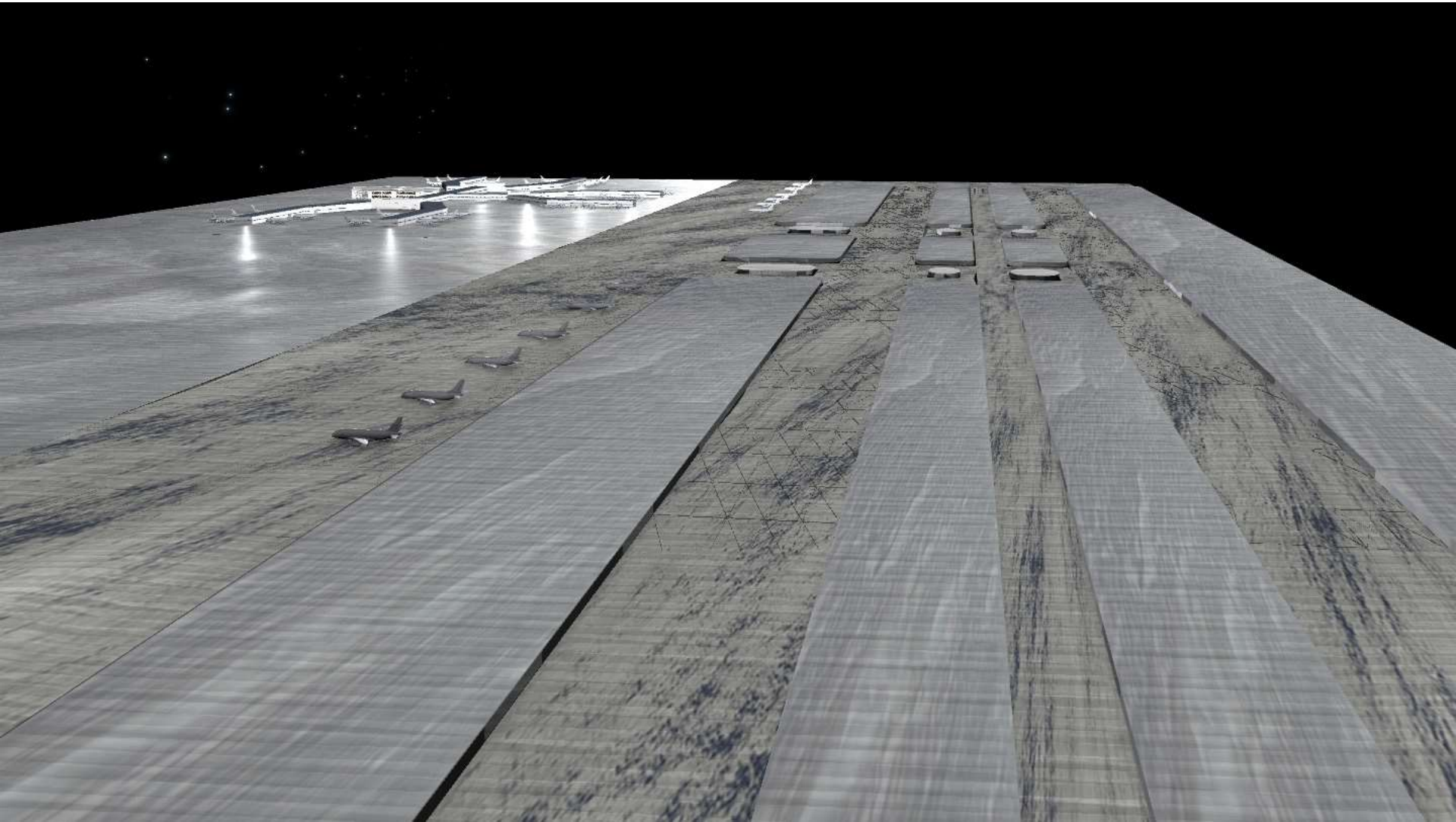

- Got heated pavements?

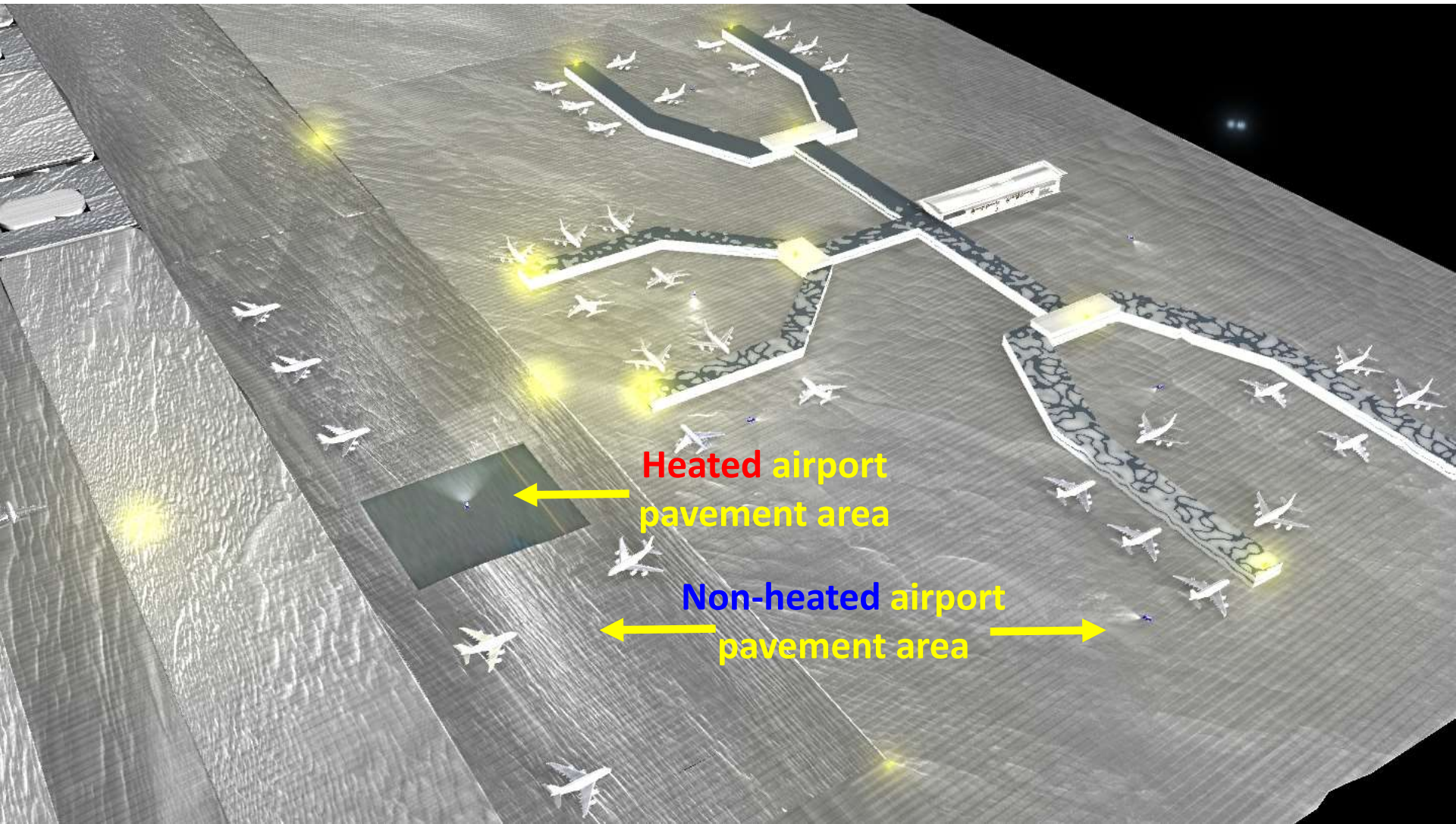



Heated Airport Pavements (Cont'd)

- Snow and ice free pavement surface

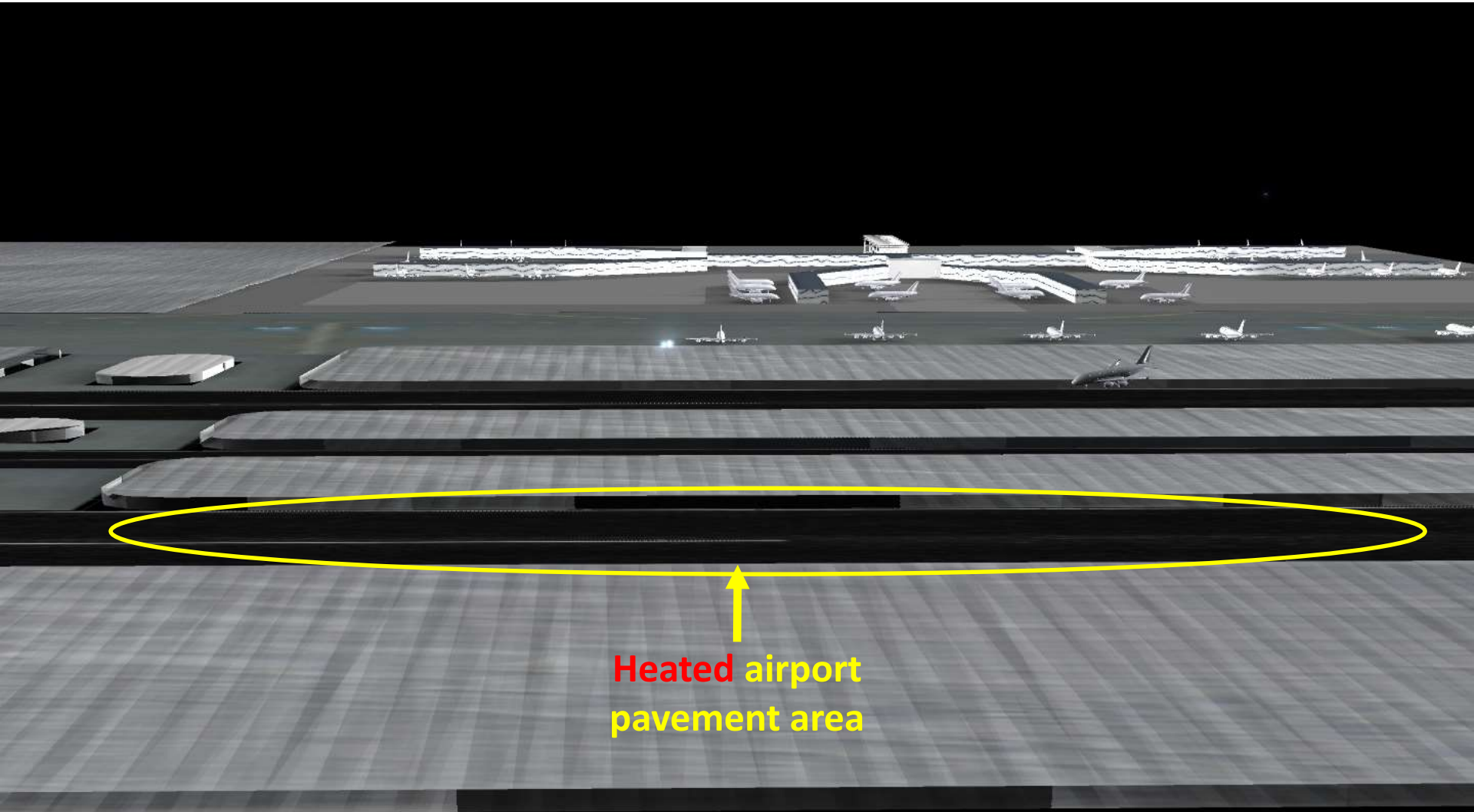

Heated vs. Unheated Aircraft Stands



**Oslo - Gardermoen Int'l
Airport in Norway (Hydronic
heating)**





Heated Airport Pavements: Types

- FAA AC 150/5370-17, “*Airside Use of Heated Pavements*”
 - **Hydronic pavement heating**
 - Direct-use of **geothermal waters** for the fluids is most efficient but may be limited to areas close to tectonic-plate boundaries
 - Other locations need to consider **ground source heat pumps, heat exchangers, or boilers** to boost efficiency and reduce the operational costs
 - **Alternative heat sources**, such as waste heat, may be utilized if a reliable supply over the whole design lifetime is guaranteed
 - **Electrically heated pavements**
 - **Insulated conductors are embedded** in the pavement, such as heating cables or grid/mesh mats
 - **Conductive materials are added** to the pavement material mix, electrical energy is applied through uninsulated conductors, and the pavement serves as the heat source

- To gain a comprehensive and practical understanding of heated concrete pavement operations through in-situ field demonstration and analytical studies
- Significant problems to be addressed include
 - Practical design alterations
 - Modifications to existing construction procedures
 - Placement issues
 - Safety of electrical systems with regard to stray currents
 - Pavement performance degradation issues resulting from thermal-mechanical-electrical interactions during heated pavement operations, etc.



Outline

- Motivation, Need and Objective(s)
- **Approach, Methods and Design**
- Construction and Performance Evaluation
- Summary

- Proposed location: Des Moines International Airport (DSM), North General Aviation (GA) Apron



- Meetings with airport manager and staff



- Proposed ECON system:
 - Slab 1: Two-layer structure
 - Slab 2: Two-layer structure

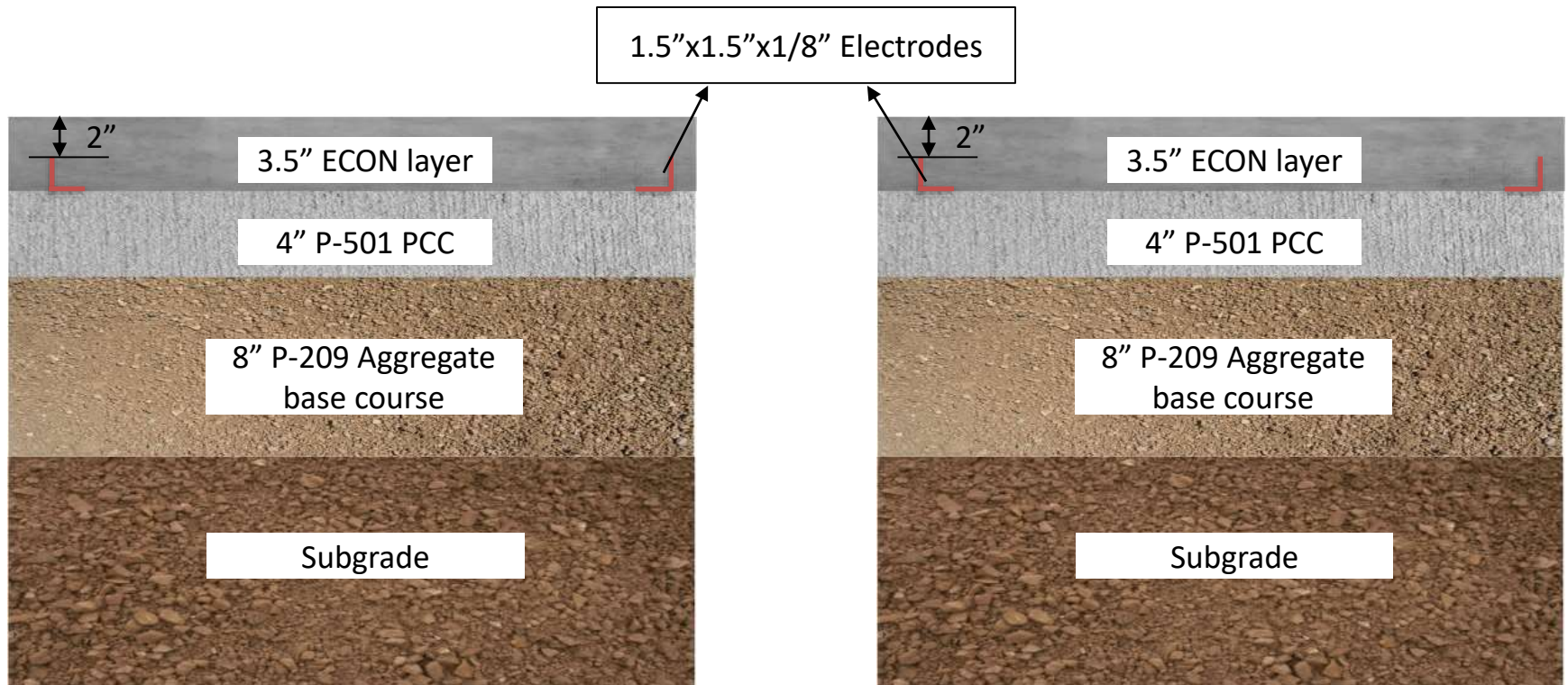

Two-layer structure

Two-layer structure



- Utilize P-501 PCC mix design provided by Foth Infrastructure and Environment, LLC and Kingston Services, LLC for bottom layer in both slabs
 - Design strength: 650 psi flexural strength
 - W/CM: 0.43
 - Air content: 6.0%
 - Slump: 1.5 in.
 - Unit weight: 144 pcf



ECON/P-501 PCC Mix Design (Cont'd)

- ECON mix design recipe
 - Based on P-501 PCC mix design provided by Foth Infrastructure and Environment, LLC
 - Considering use of ready mix concrete for paving

- ECON mix design (ECON mix at ISU PCC lab)





Electrodes, Sensors, and Other Materials

- Electrodes (12 electrodes)
- Sensors
 - Thermocouple type T (68 sensors)
 - 5TE moisture, temperature, and electrical conductivity sensor (4 sensors)
 - Strain gages, Geokon (16 sensors)
 - Digital temperature and humidity sensor SHT71, Sensirion (4 sensors)
 - Wireless temperature sensors (2 sensors)
 - Wireless humidity sensors (2 sensors)
- Sensor trees (26 sensor trees)
- Sensor chairs (16 sensor chairs)
- PVC pipe and junction box

- Electrodes layout plan
 - Placing 6 electrodes per a slab

Slab 1

Slab 2

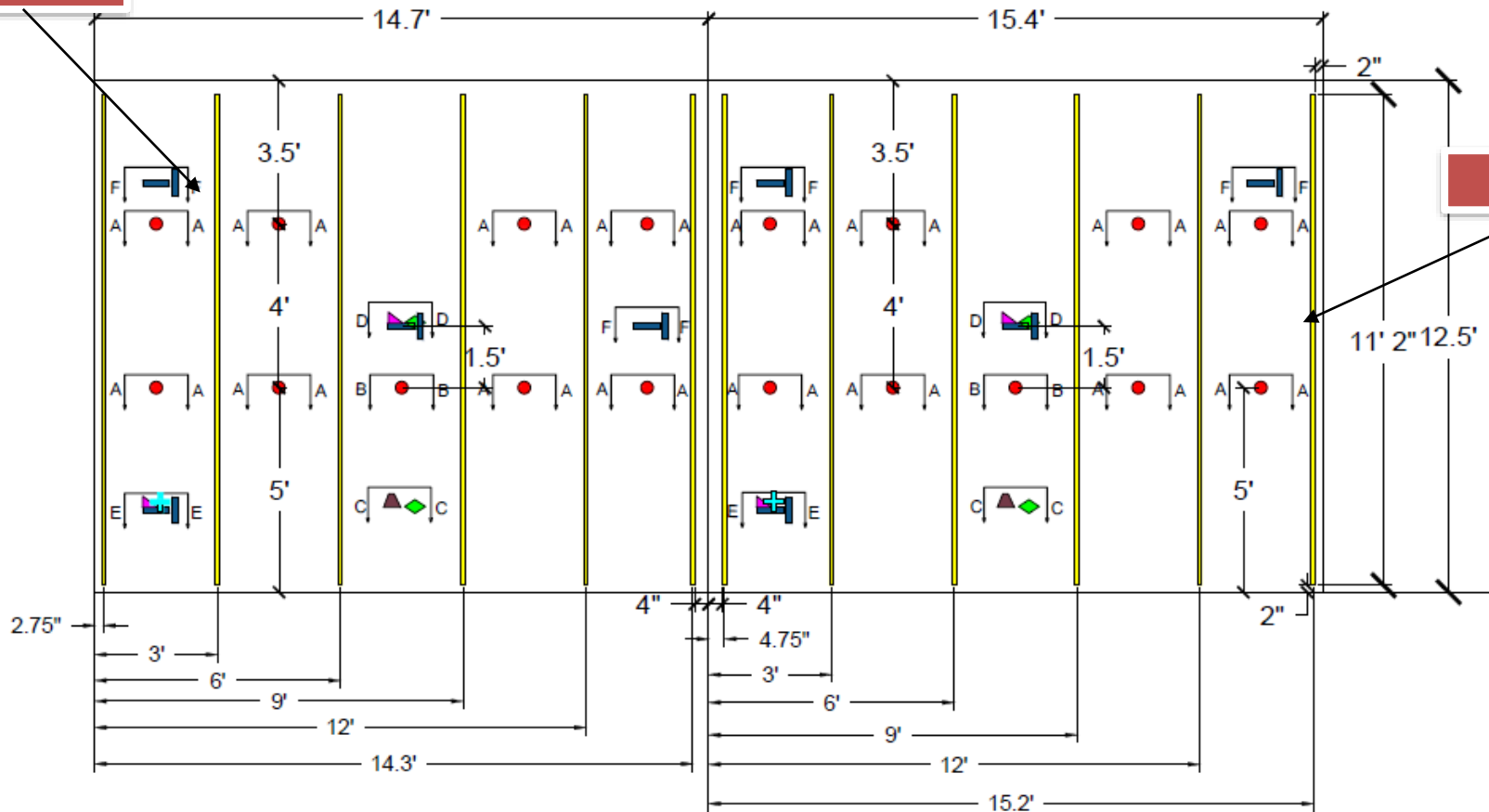

- Placing fiberglass rebar on top of electrodes to prevent cracking due to environmental load

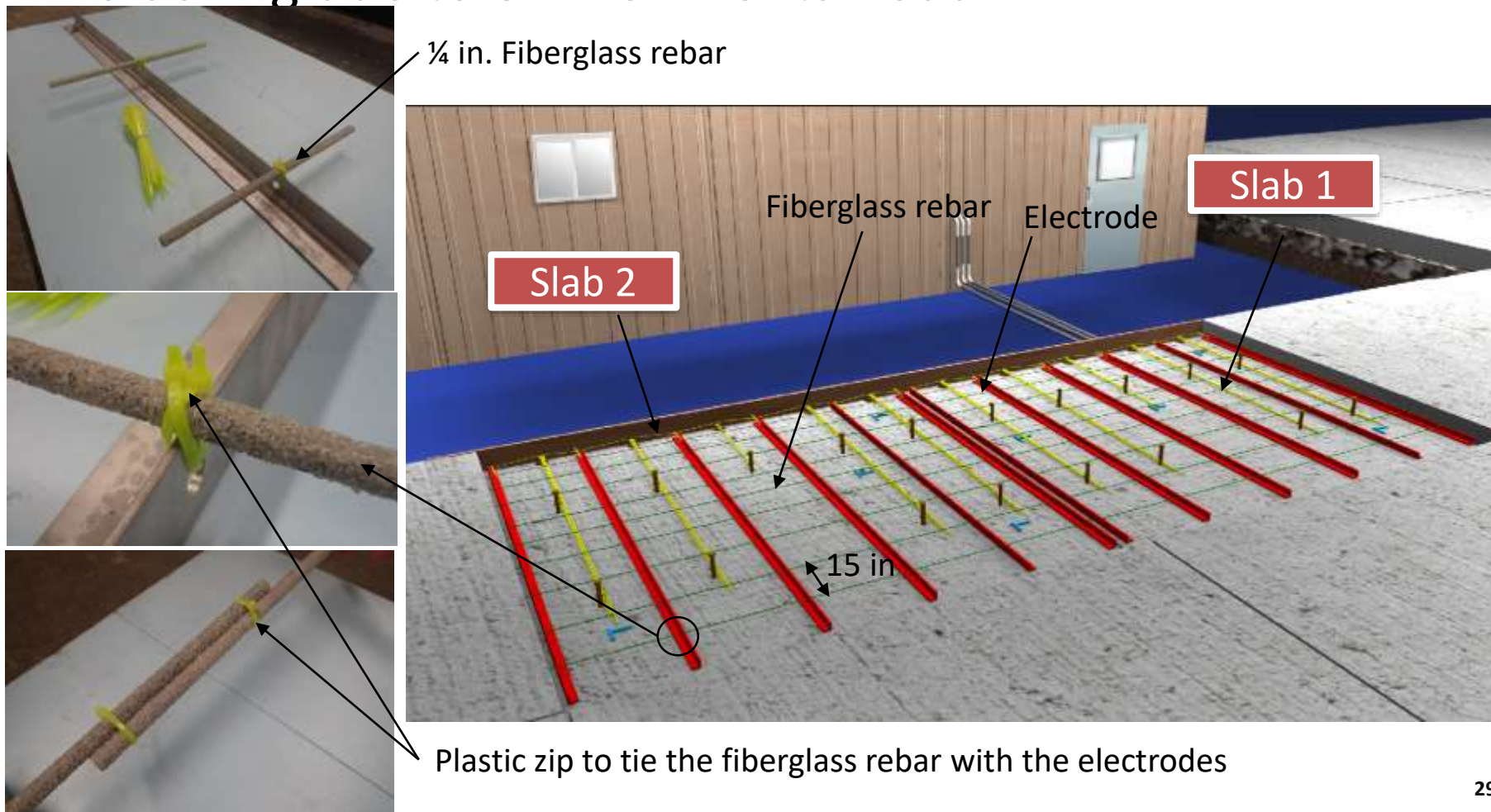

- Placing fiberglass rebar on top of electrodes to prevent cracking due to environmental load

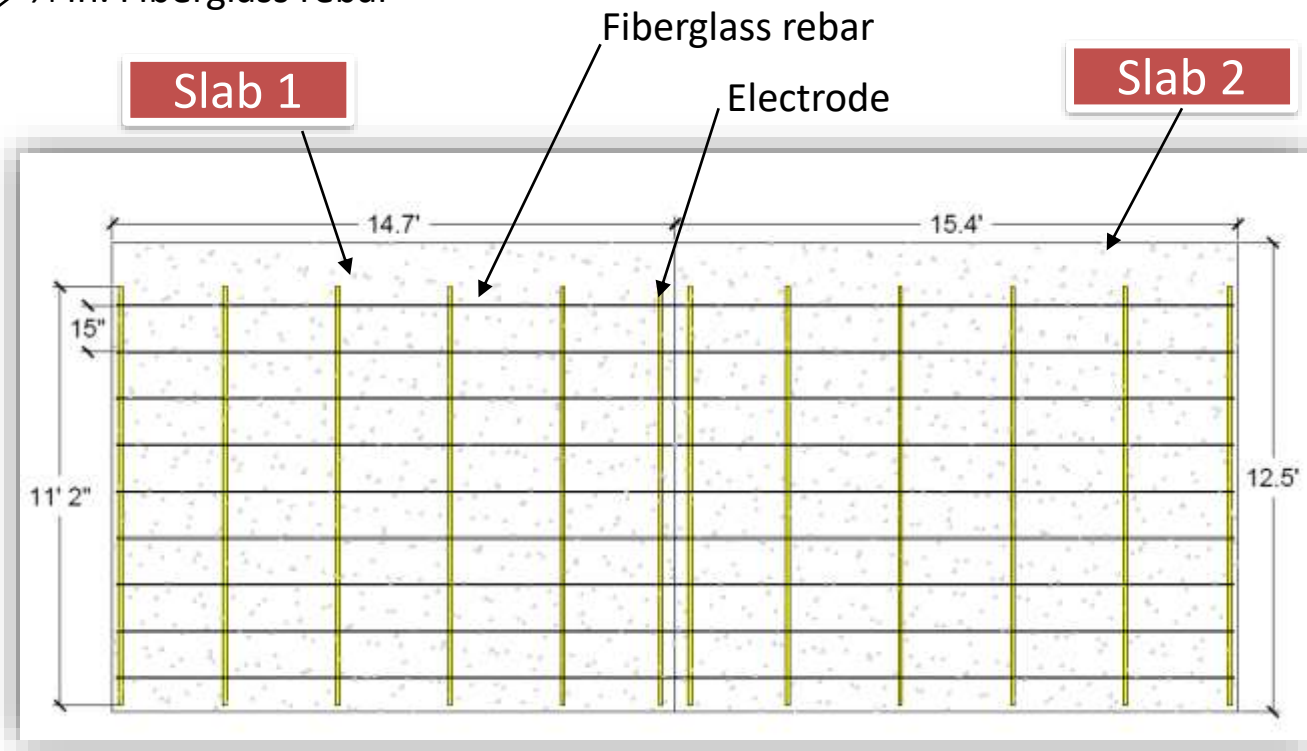
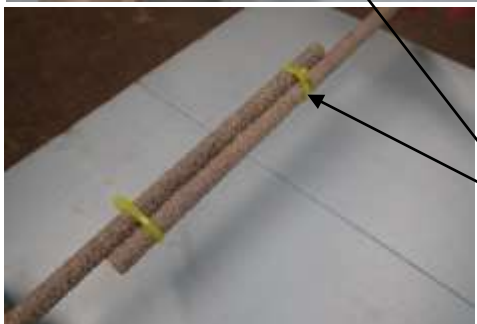
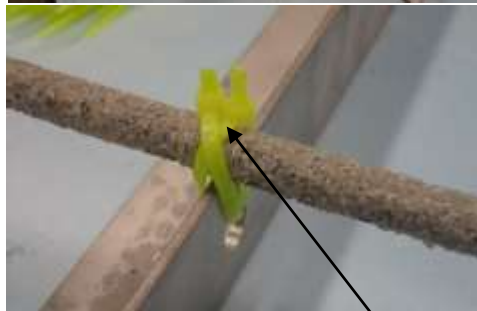
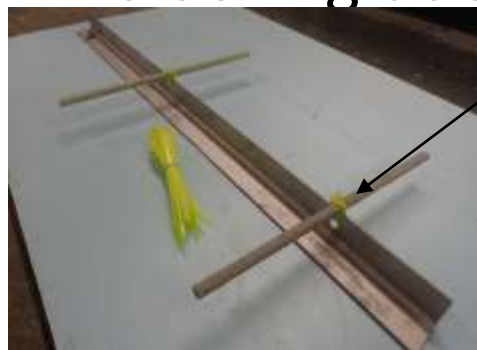

Plastic zip to tie the fiberglass rebar with the electrodes

- Sensor layout plan

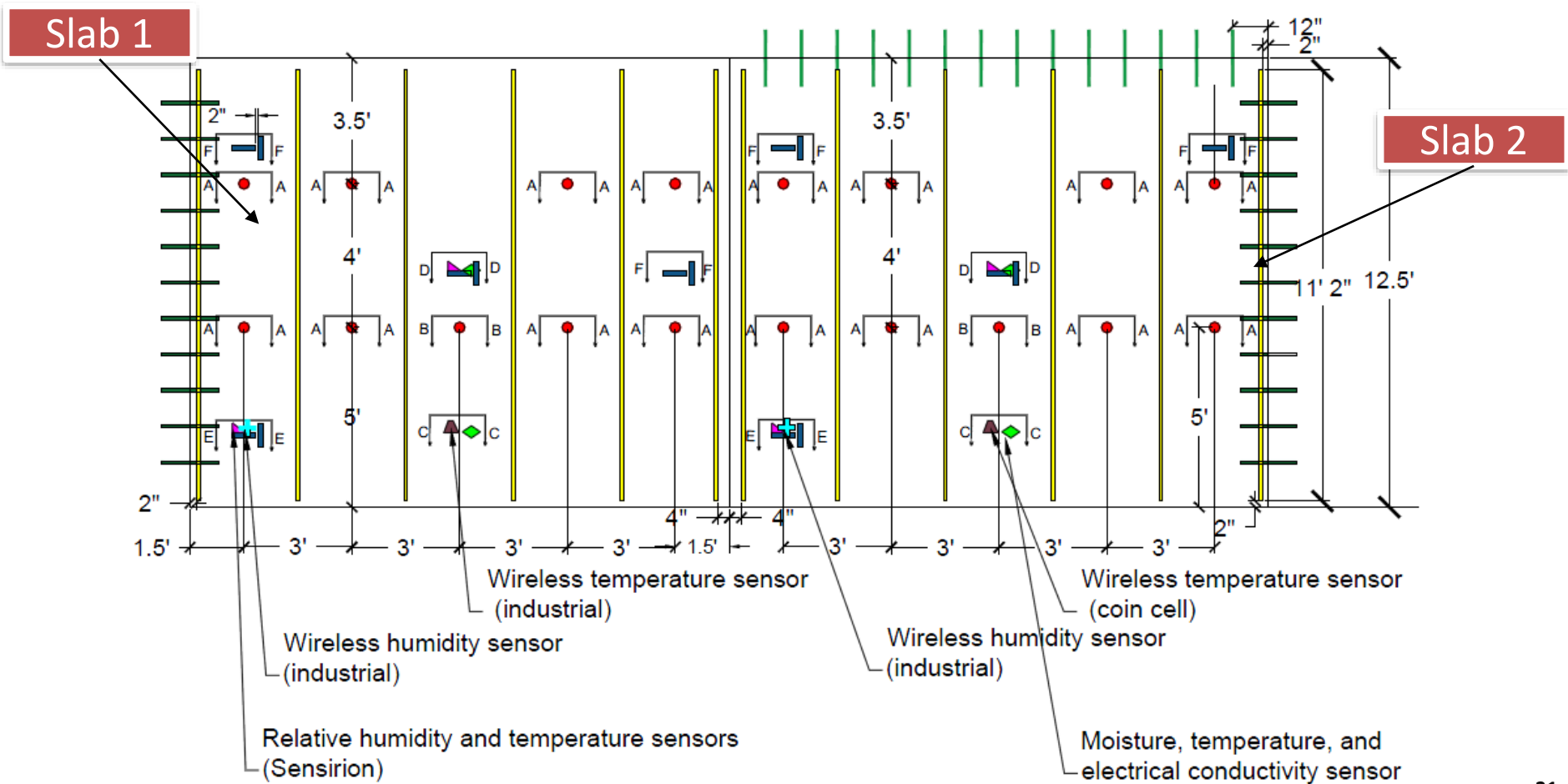

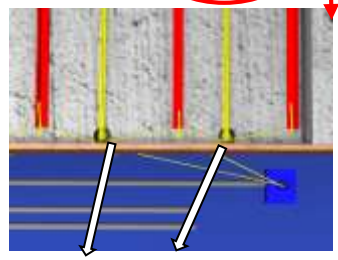
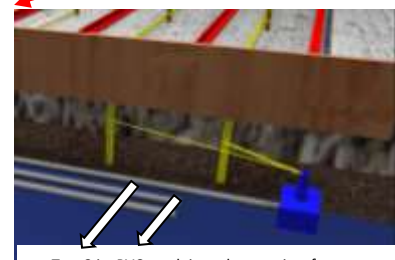
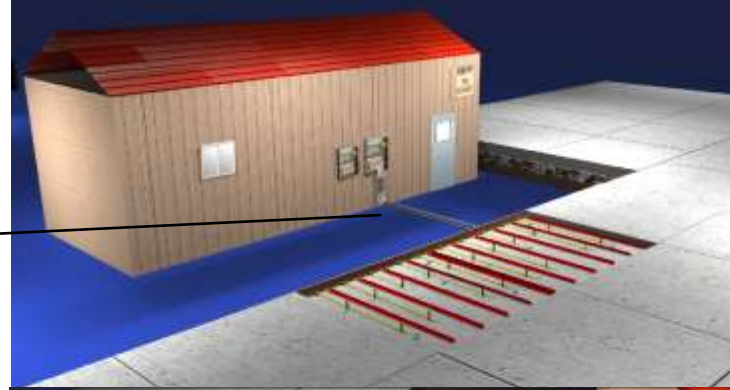
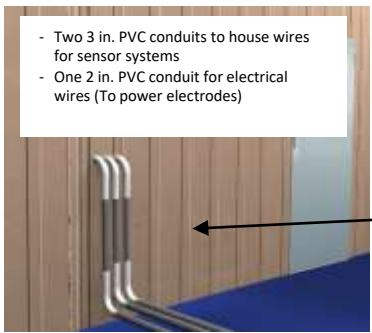
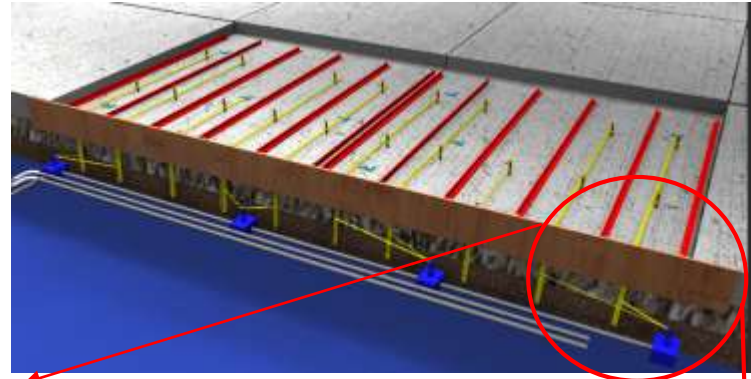
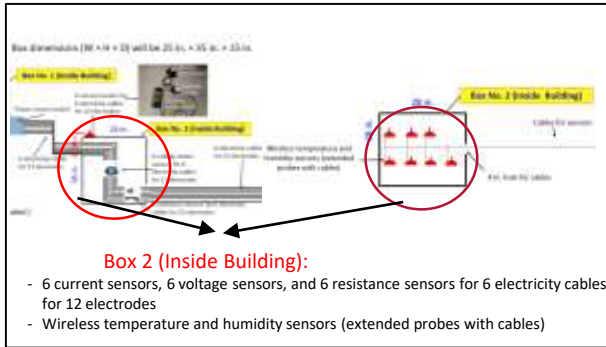
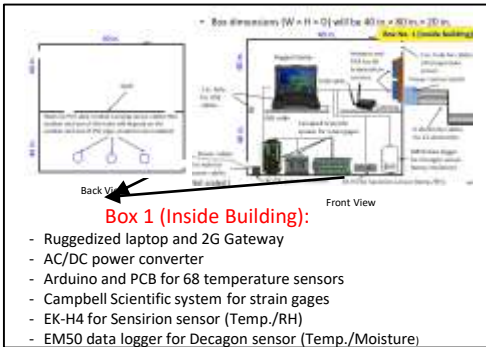

- Two 3 in. PVC conduits to house wires for sensors system and each PVC conduit will carry 50 wires (total 100 sensors)
- One 2 in. PVC conduit to house electrical wires (electrodes) (total 6 wires for 12 electrodes)

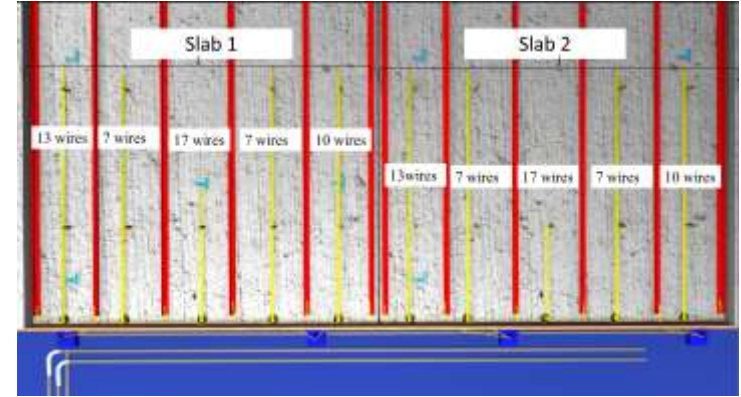
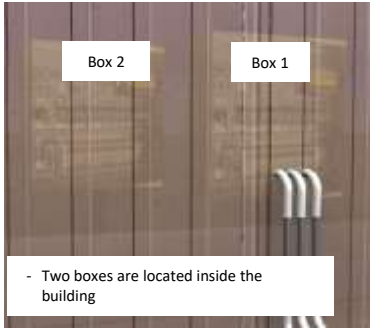

- Utilize existing electrical power supply nearby building 69 on the inside
 - Single-phase panel 120/240V, 200 A power is available in the building 69 (hangar)
 - The electrical control box consists of:
 - Power meter
 - Temperature sensing
 - Power switching on/off unit
 - Circuit breakers



Electrical control box

- Power supply and data acquisition systems



- Power supply

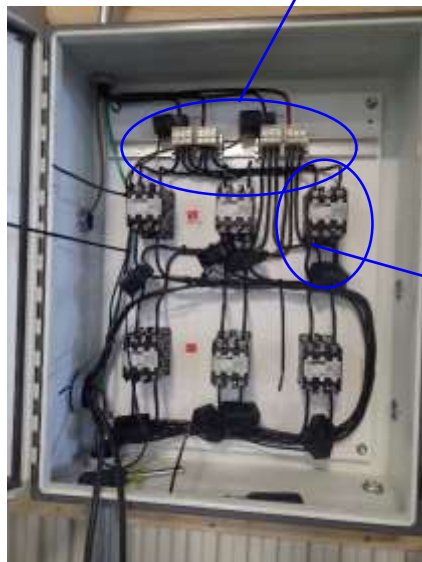

Contactor



Circuit breaker
60A for each slab



Single-phase panel
120/240V, 200 A

DSM International Airport Heated Pavement System Automation Flowchart

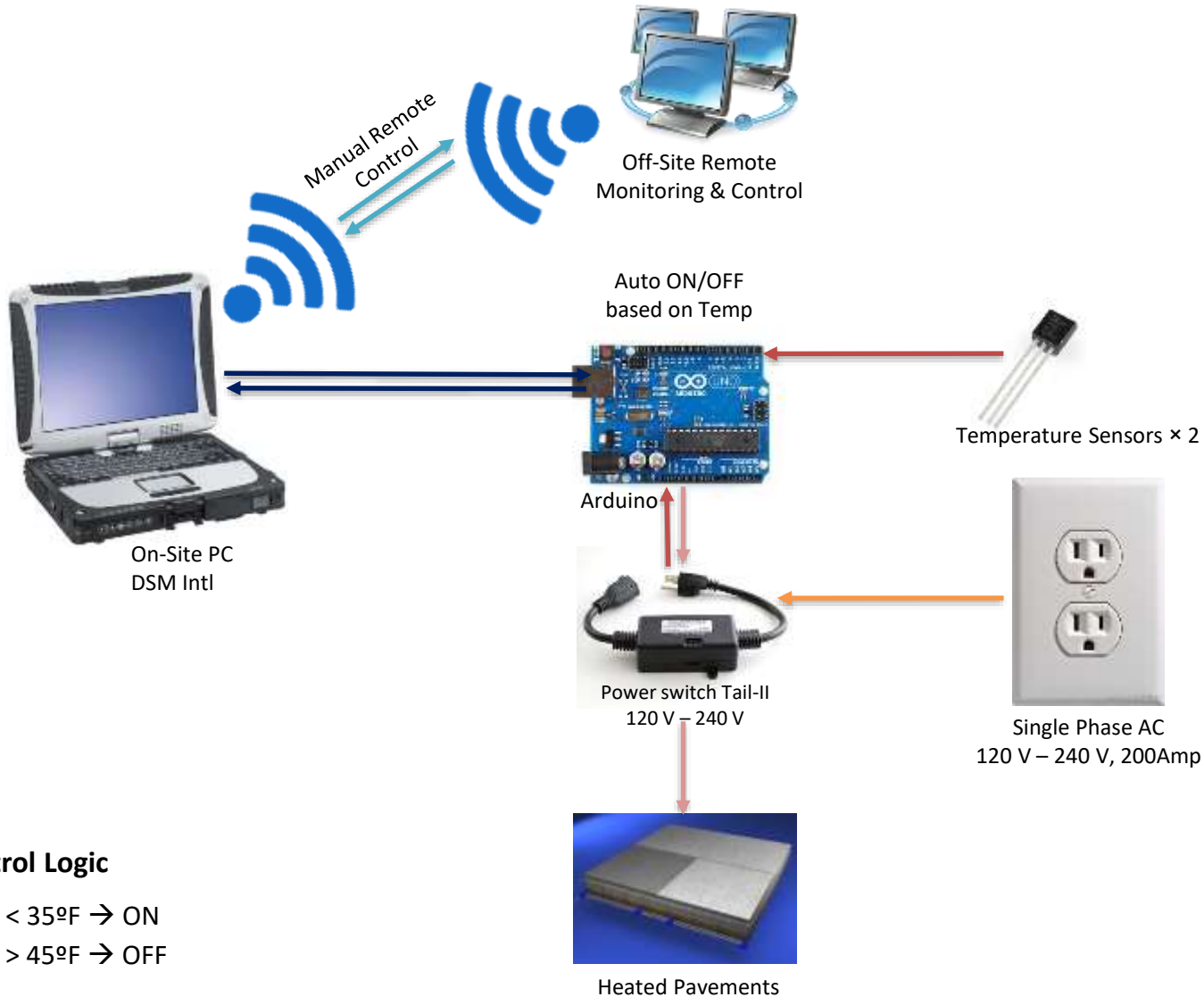

Control Logic

If $T < 35^{\circ}\text{F} \rightarrow \text{ON}$
 Else if $T > 45^{\circ}\text{F} \rightarrow \text{OFF}$

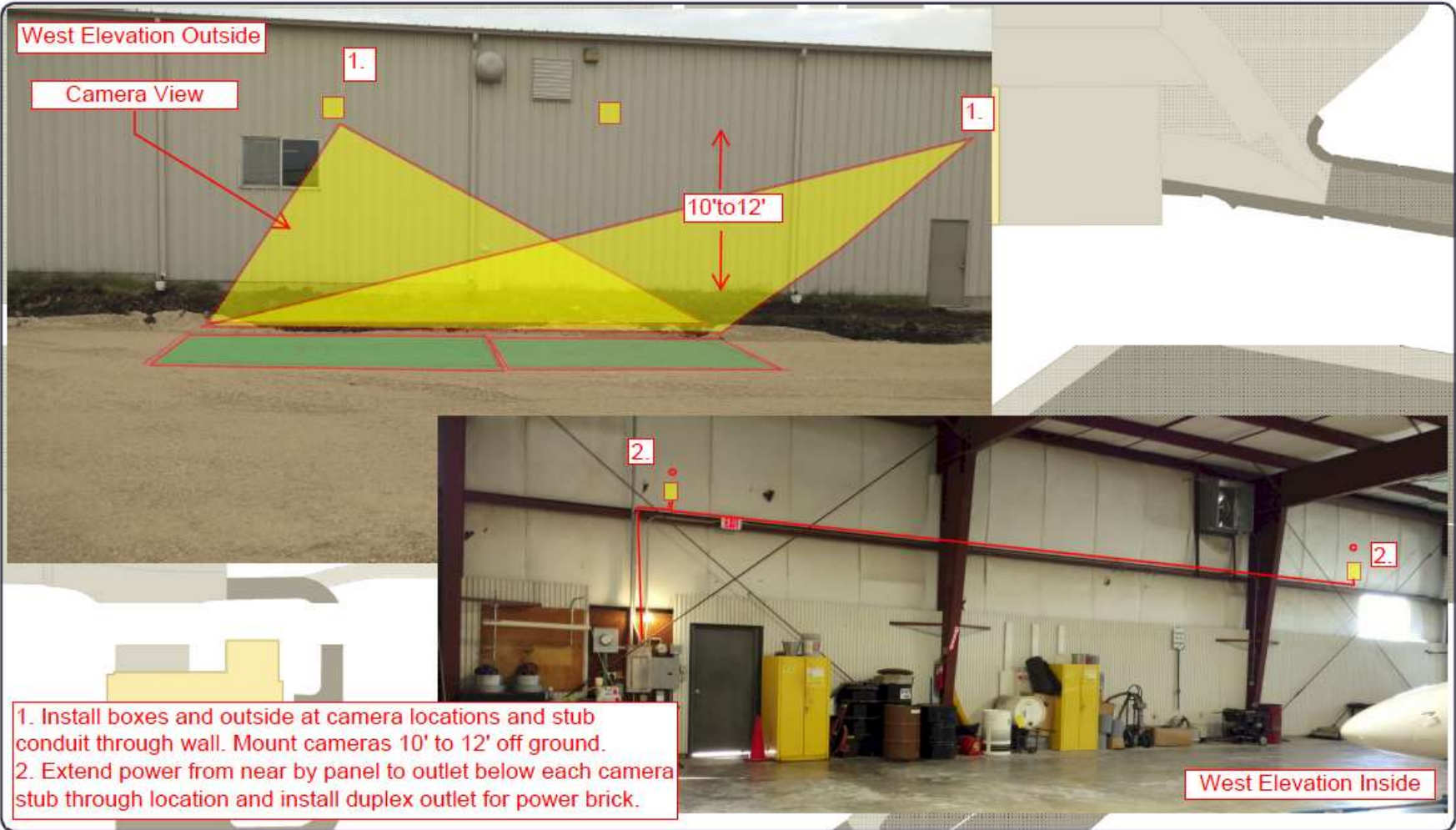



- Motivation, Need and Objective(s)
- Approach, Methods and Design
- **Construction and Performance Evaluation**
- Summary

- Step 1: Prepare 8 in. of P-209 aggregate base course



- Step 2: Placing PVC conduits (10 of them, 5 for each slab) to house wires for sensor systems and electrodes
 - Diameter: 2 in, Length/Height: 4 in



- Step 3: Placing 4 in. P-501 PCC on 8 in. of P-209 aggregate base course



- Step 4: Placing three wireless sensors
 - Two wireless humidity industrial sensors (one per slab)
 - One wireless temperature sensor (mounted on the wall)



Two wireless humidity sensors



One wireless temperature sensor-coin

- Step 5: Installing two surveillance cameras



- Step 6: Marking sensors location and drilling holes for sensor trees



Holes to house wires for sensors system and electrodes



- Step 7: Placing PVC conduits (10 of them, 5 for each slab) to house wires for sensor systems and electrodes
 - Diameter: 1 in, Length/Height: 180 in



- Step 8: Placing sensors



- Step 9: Placing the wires through PVC conduits and connected to the data logger



- Step 9: Placing the wires through PVC conduits and connected to the data logger (Cont'd)

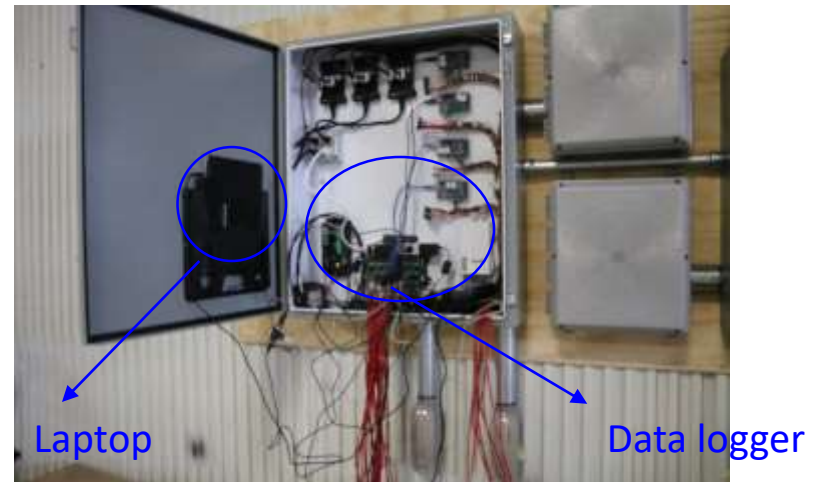

- Step 10: Installing the power supply (contactors) and electrical sensors

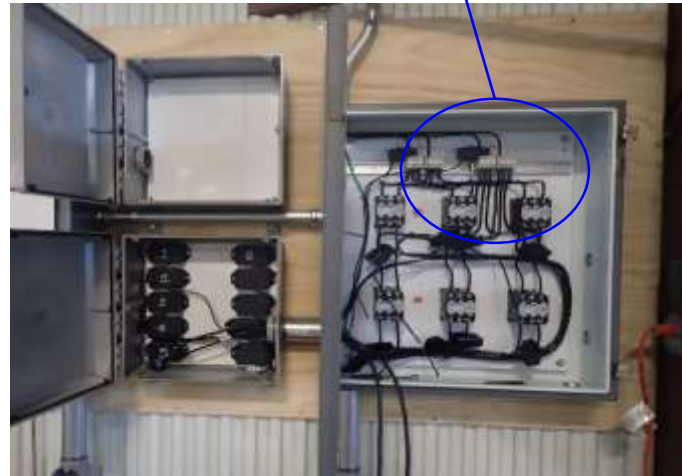

- Step 11: Placing fiberglass rebar on top of electrodes to prevent cracking due to environmental load



- Step 12: Clearing and preparing the ECON slabs before paving
 - Cleaning the surface by using air-blower



- Step 12: Clearing and preparing the ECON slabs before paving (Cont'd)
 - Distributing the wires bundle to prevent cracking from edges



- Step 13: ECON mixing at the ready mix plant
 - Date: 11/04/2016



- Step 13: ECON mixing at the ready mix plant (Cont'd)
 - Delivery of the ECON mixture



- Step 14: Preparing and placing concrete screed



- Step 15: ECON paving
 - Paving time: 2:30 PM, Date: 11/03/2016



- Step 15: ECON paving (Cont'd)



- Step 15: ECON paving (Cont'd)



- Step 15: ECON paving (Cont'd)



- Step 15: ECON paving (Cont'd)



- Step 15: ECON paving (Cont'd)



- Step 15: ECON paving (Cont'd)



- Step 15: ECON paving (Cont'd)



- Step 16: Visual observation next day after ECON paving
 - No crack was observed on ECON surface



- Full-scale demonstration of heated portland cement concrete pavement systems: **Des Moines international airport heated concrete pavements**





Outline

- Motivation, Need and Objective(s)
- Approach, Methods and Design
- Construction and Performance Evaluation
- **Summary**

- Heated pavements are viable options from economic, energy consumption, and environmental sustainability perspectives
- Efficiency of heated pavements could be improved through:
 - Improving material properties and performance (i.e. ECON, superhydrophobic materials, and PCM)
 - Integration of advanced construction techniques
- Economic analysis results greatly depend upon the size of the airports in terms of number of aircraft operations and pavement area
 - Large hub airports could gain more financial benefits



Summary: Overall Benefits

- Facilitates expedited and efficient snow and ice removal operations that can reduce traffic delays, especially at large airports
- Eliminates the risk of airplanes skidding off the runways, high-speed taxiways, etc.
 - No accidents, injuries or fatalities!
- Reduces the downtime required to clear ice and snow
- Improves safety for ground crews servicing the aircraft at the gate areas
- Improves safety of passengers embarking/disembarking the aircraft



Summary: Overall Benefits (Cont'd)

- Improves air travel capacity during winter operations. Utilization of HPS helps keep the airports open and accessible during winter operations enabling safe and happy travels for the passengers
- Reduction in time required to clear snow/ice in priority areas
- Provides a platform for the development of innovative anti-icing systems such as nanostructured superhydrophobic coatings and systems, conductive paving materials, etc.
- Provides efficient operation time window, i.e., the HPS deicing operation can be automated to start and end exactly for the duration of ice and snow formation
 - Heating process can be initiated ahead of ice/snow storm and can be automated by using sensor systems



Summary: Overall Benefits (Cont'd)

- Reduces the amount of labor and equipment costs associated with using/applying deicing methods
- A viable option from an energy or financial viability perspective for achieving pavement surfaces free of ice/snow without using mechanical or chemical snow and ice removal methods
 - Benefit-to-cost ratios are greater than 1.0 for a large number of airports studied!
- It is anticipated that with the installation of HPS the passengers' lost time would substantially decrease
 - Operation costs can be reduced by judicious use of HPS and appropriate weather monitoring. Advancements in HPS technology and construction practices are expected to greatly bring down the installation costs



Thank You!
Questions & Comments?

