

2<sup>nd</sup> INTERNATIONAL CONFERENCE

# TIMBERBRIDGES

LAS VEGAS 2013

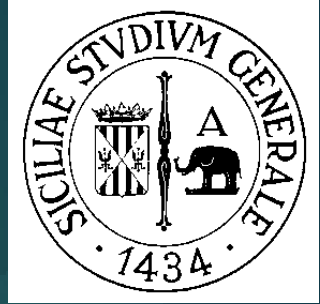
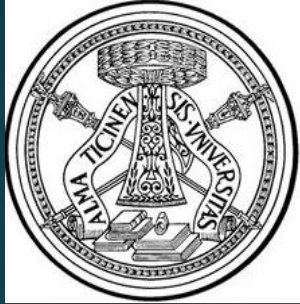

## *Dynamic Response of a Timber Pedestrian Bridge*

- Comparison of accelerometric response records -

**D. Bortoluzzi<sup>1</sup>, F. Casciati<sup>1</sup>, S. Casciati<sup>2</sup> and L. Faravelli<sup>1</sup>**

<sup>1</sup> Department of Civil Engineering and Architecture, University of Pavia, via Ferrata 1, 27100 Pavia, Italy, Tel: (+39) 0382 985459; lucia@dipmec.unipv.it; daniele.bortoluzzi@unipv.it

<sup>2</sup> Dept. DICA, Dipartimento di Ingegneria Civile e Ambientale, School of Architecture, University of Catania at Siracusa, Piazza Federico di Svevia, 96100 Siracusa, Tel.: (+39) 338 5953658 e-mail: saracasciati@msn.com

# OUTLINE

2

- Introduction
- Case Study: Cycle-pedestrian Timber bridge Trasaghis
- FE Model
- Experimental campaigns plan
- Experimental results
- Conclusions

# INTRODUCTION (1)

3

- Timber is very **sensitive to environmental conditions** (i.e. air moisture, temperature...);
- Wooden elements in general, **require a continuous maintenance** in order to preserve their strength and architectural appearance.



...the idea...

...identify structural response modifications (if any) from modifications due to different environmental conditions.

# INTRODUCTION (2)

...how to do this?

- **Best solution: Continuous Monitoring:** possible only if adequate lodgment for the sensors are designed.
- **Practicable way: Periodical Monitoring.** This implies the necessity to separate, as said, structural modifications (if any) from the response modifications associated with different environmental situations.

# CASE STUDY (1)

5

Trasaghis (UD) → North-East of ITALY

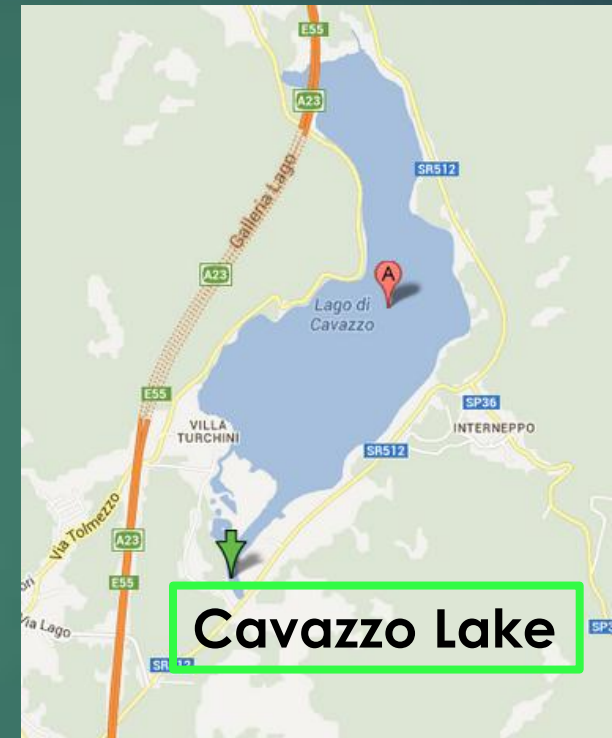



# CASE STUDY (2)

6

## *Cycle-pedestrian Timber bridge Trasaghis*

To harmonize the structure with the naturalist park surrounding the lake, only **timber** and **steel** were employed, limiting the use of the reinforced concrete only for the foundations. In particular **glued laminated timber (GLT)** of high strength GL28c and GL24c, and steel elements of strength S355JR were adopted (according to **EuroCode**).



# CASE STUDY (3)

7

- Static scheme inspired by “cable-stayed bridge” where the cables are replaced by tubular steel elements.
- The span's length is 83 m and the deck's width is 3.82 m, of which 3.22 m represents the free crossing width. Antenna's height about 15 m.



# CASE STUDY (4)

8

More in **details about the deck**:

- 2 main curved GLT beams 20x194 cm posed over «neoprene» supports;
- Tubular H-shape transversal steel elements;
- 5 longitudinal GLT beams & timber walkway;
- steel braces.

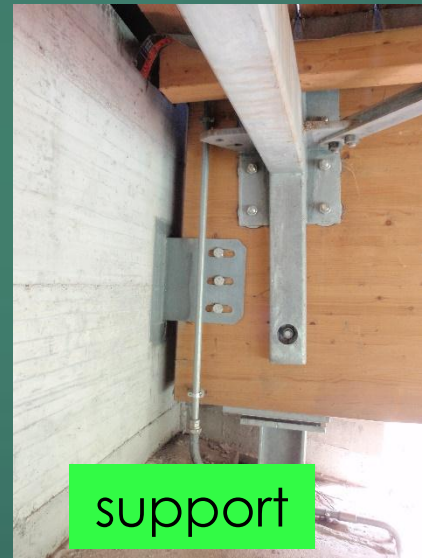
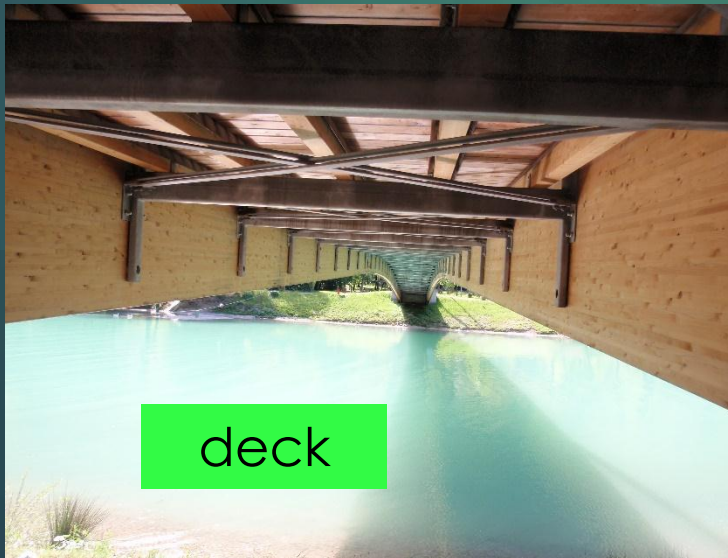



# CASE STUDY (5)

9

...about the deck...

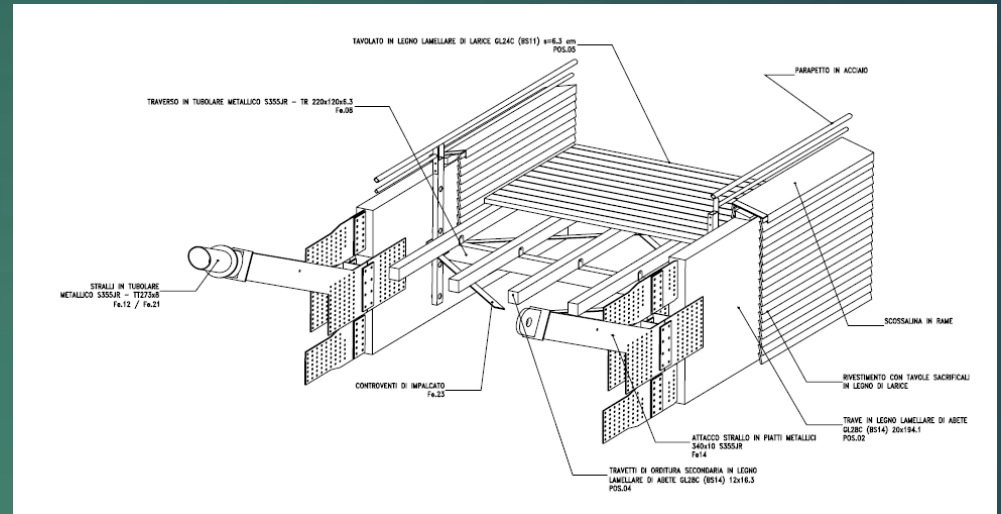

# CASE STUDY (6)

10

...great importance has been given to the **durability**.



upper protection made  
by a sheet of copper



external larch cladding



# CASE STUDY (7)

11

...a couple of picture...



# CASE STUDY (7)

12



view from the bottom...





# CASE STUDY (8)

13

...view of the deck's shape...



2<sup>nd</sup> INTERNATIONAL CONFERENCE

**TIMBERBRIDGES**

LAS VEGAS 2013

# FE MODEL (1)

14

Wood behavior → orthotropic behavior

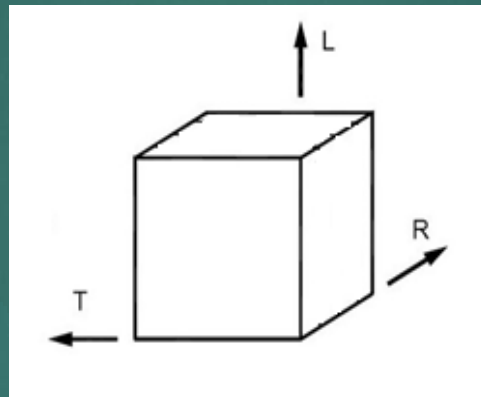
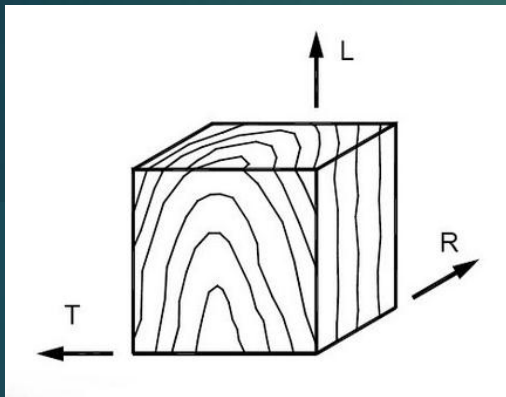

<i>Poisson</i>	Conipher
$\nu_{LR}$	0,37
$\nu_{LT}$	0,42
$\nu_{RT}$	0,47

Steel behavior → isotropic behavior

# FE MODEL (2)

15

From the «design technical documents» to FEM model using **Marc MENTAT2010** code.

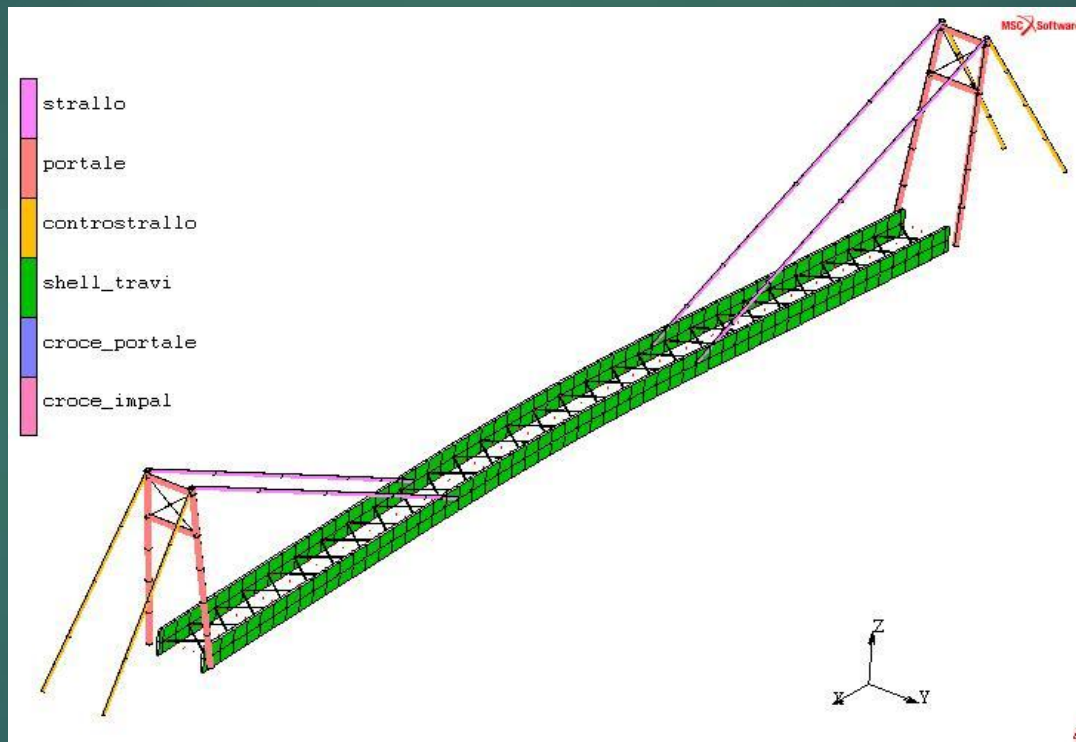

# FE MODEL (3)

16

...a couple of picture...

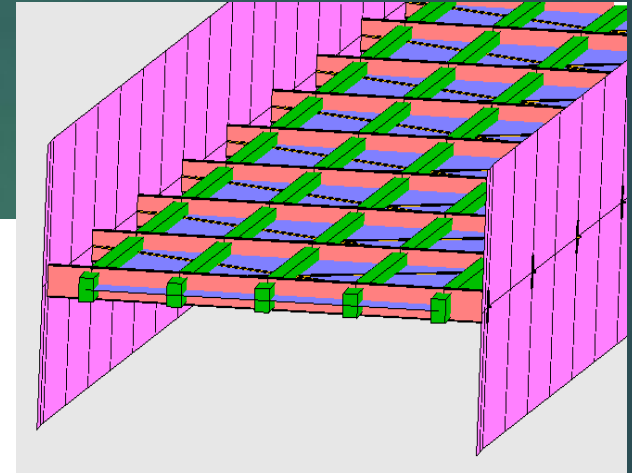
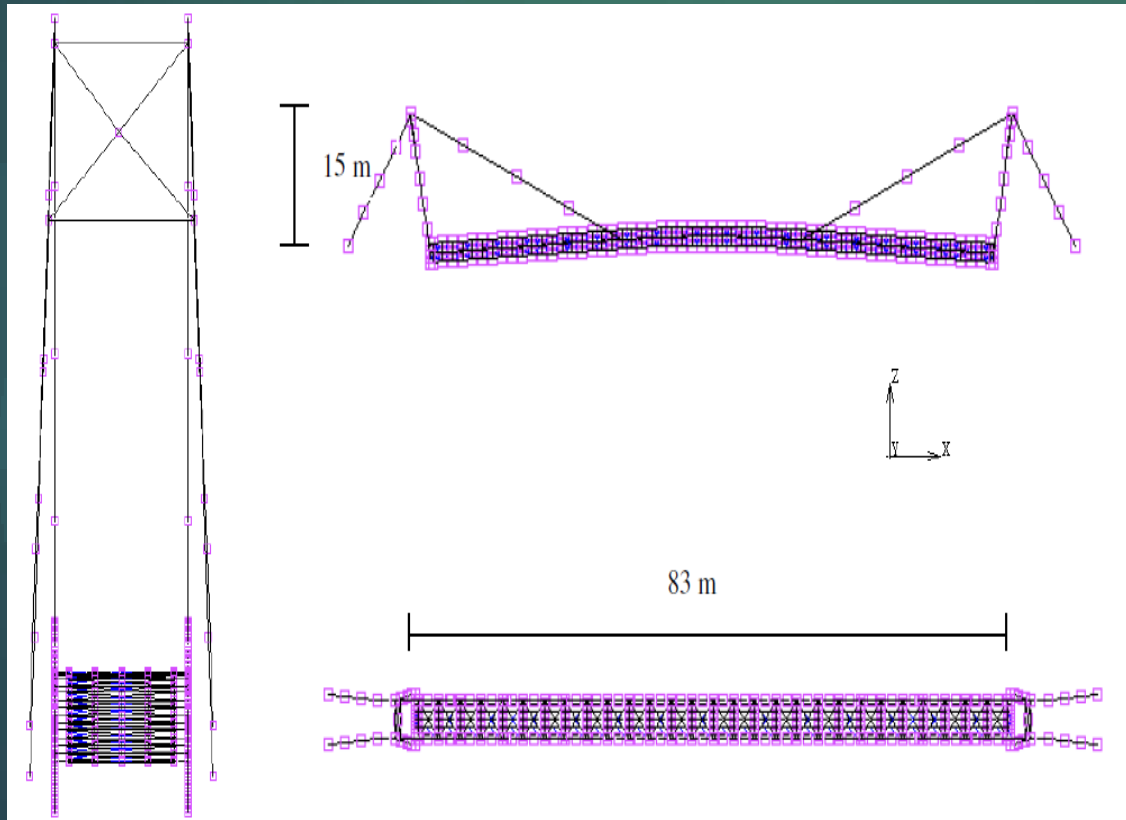



# FE MODEL (4)

17

...for the antenna...

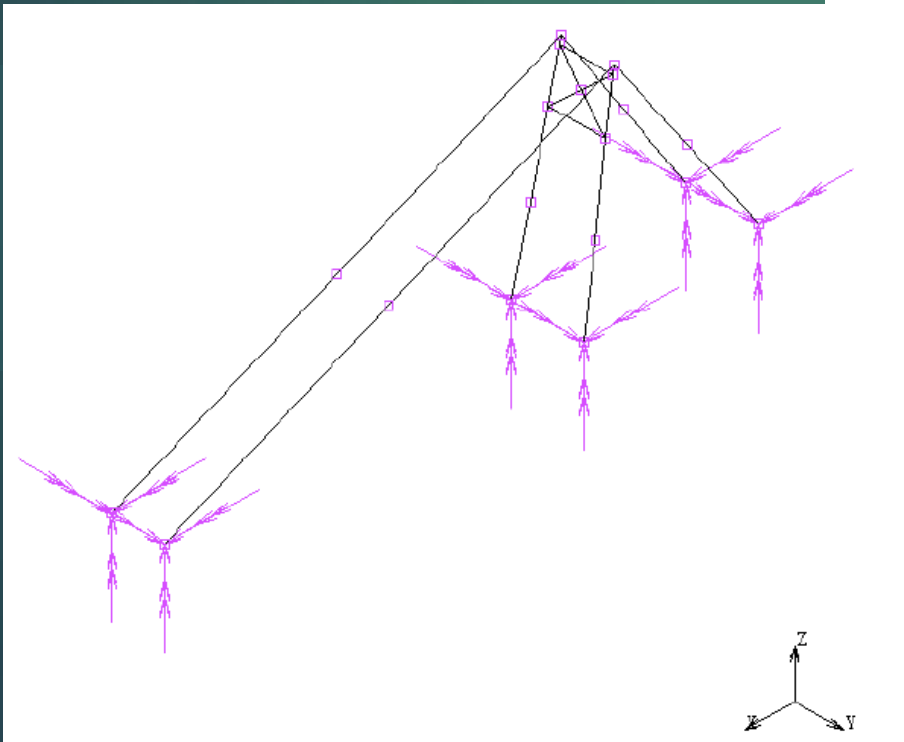

# FE MODEL (5)

18

*Numerical results in terms of frequency range for different boundary conditon for the deck.*

Frequency [Hz]	$f_1$	$f_2$	$f_3$	$f_4$
fixed ends	1.52-1.54	3.43	5.60-6.61	8.73
A - free vERTICAL translation	1.52-1.54	3.43	5.60-6.61	8.73
B - free transversal translation	0.39-2.06	3.43	5.52-6.60	8.66
C - free rotation around the transversal axis	1.07-1.54	3.43	4.25-6.61	8.40
D – free rotation around the vertical axis	1.08-1.54	3.36	4.33-6.56	8.73
A+B	0.39-2.05	3.46	5.52-6.73	8.66
C+D	1.07-1.09	3.36	4.25-6.56	8.40
A+C+D	1.07-1.09	3.35	4.20-6.54	8.37

The experiments carried out in field consisted in the recording of the accelerations of some relevant points of the bridge under environmental loads → **wind load**.

## Challenges:

1. replace the standard wired acquisition system with a **wireless system developed by the authors**;
2. develop a reliable process to **clean the effect of current environment condition**, that might afflict different experimental campaigns.



## ...about the instrumentations...

Acquisition system →

Wireless Data Acquisition System (WDAQS) developed by the authors

Instrument:  
Accelerometers  
(EpiSensor)

Mono-axial  
(4 accelerometers)



Three-axial  
(4 accelerometers)



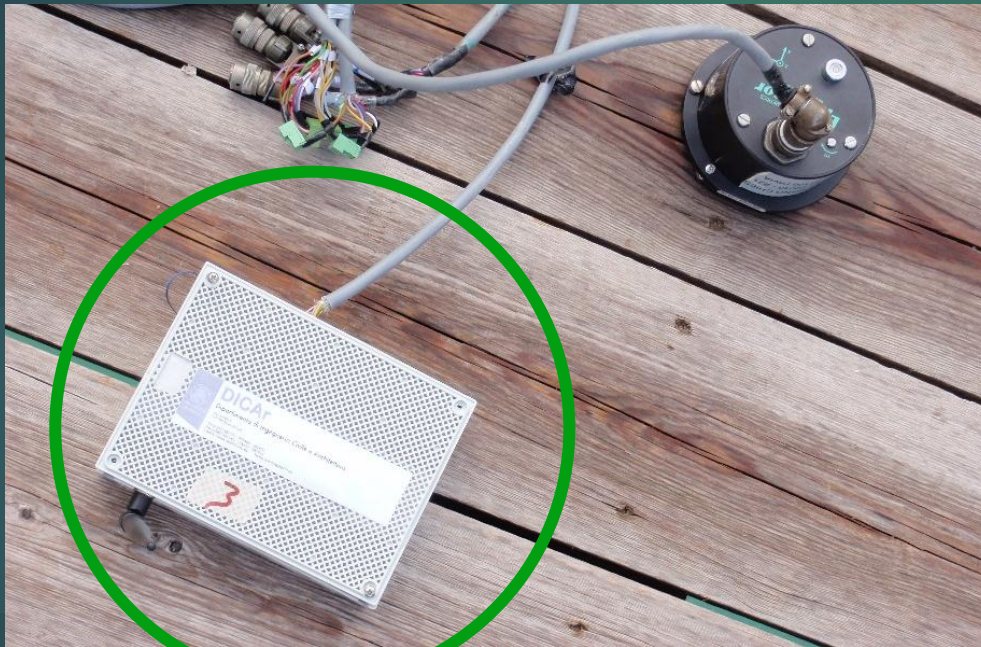

WSU



Tri-axial accelerometer connected with a wireless sensor unit (WSU) posed over the bridge's deck

Two experimental test:

- First one: November 30th, 2012 – average air temperature during the acquisition about 10 °C.
- Second one: May 12nd, 2013. Two set of data are reported:
  - ✓ 9:30 am – air temperature 15,5 °C,
  - ✓ 12:00 pm air temperature 25 °C.

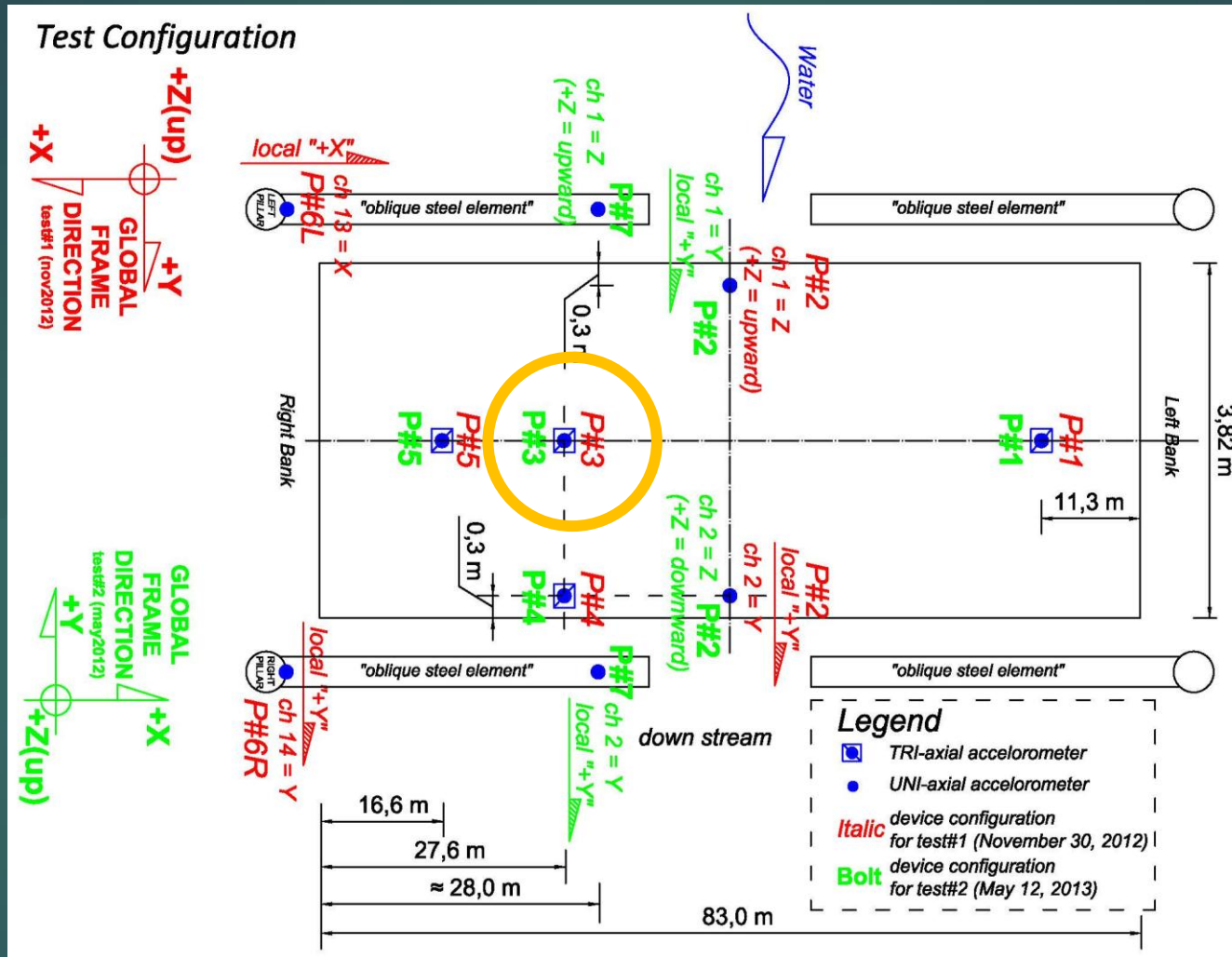

green → test: November 2012;  
 red → test: May 2013.



# EXPERIMENTAL CAMPAIGN PLAN (7)

25

...a couple of picture...



...now we can move to the **discussion of the result**...All the results, hereinafter, are represented in terms of **acceleration's peridiograms** collected along **Y** (transversal) and **Z** (vertical) axes by the sensor located in **POSITION 3** → Tri-axial accelerometer about 27 m far from the right bank.

# EXPERIMENTAL RESULTS (1)

27

## a) Peridiograms for the acceleration **along Y** (transversal axe)

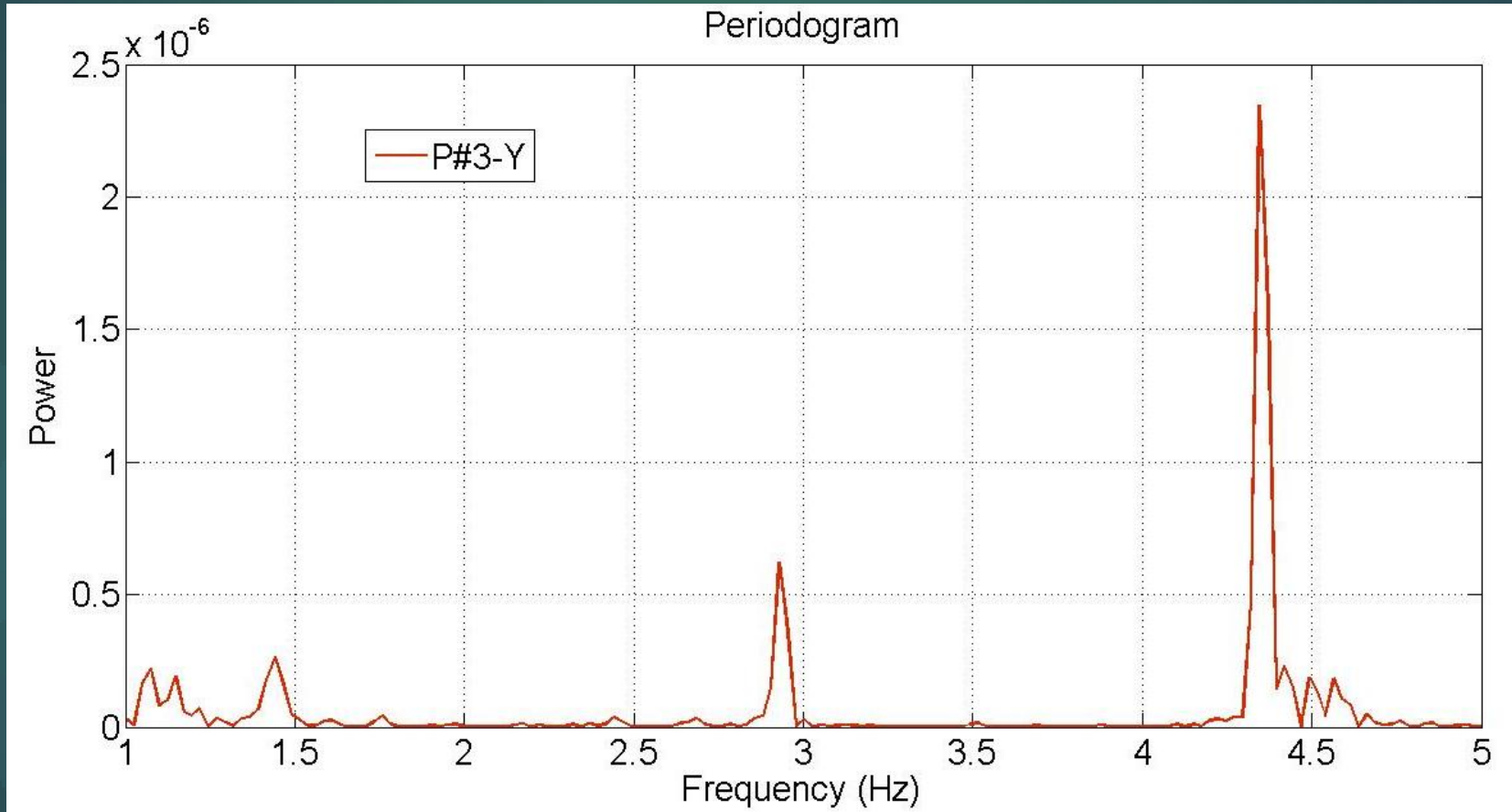

P#3 – November 30<sup>th</sup>, 2012 @ early morning

# EXPERIMENTAL RESULTS (2)

28

## b) Peridiograms for the acceleration **along Y** (transversal axe)

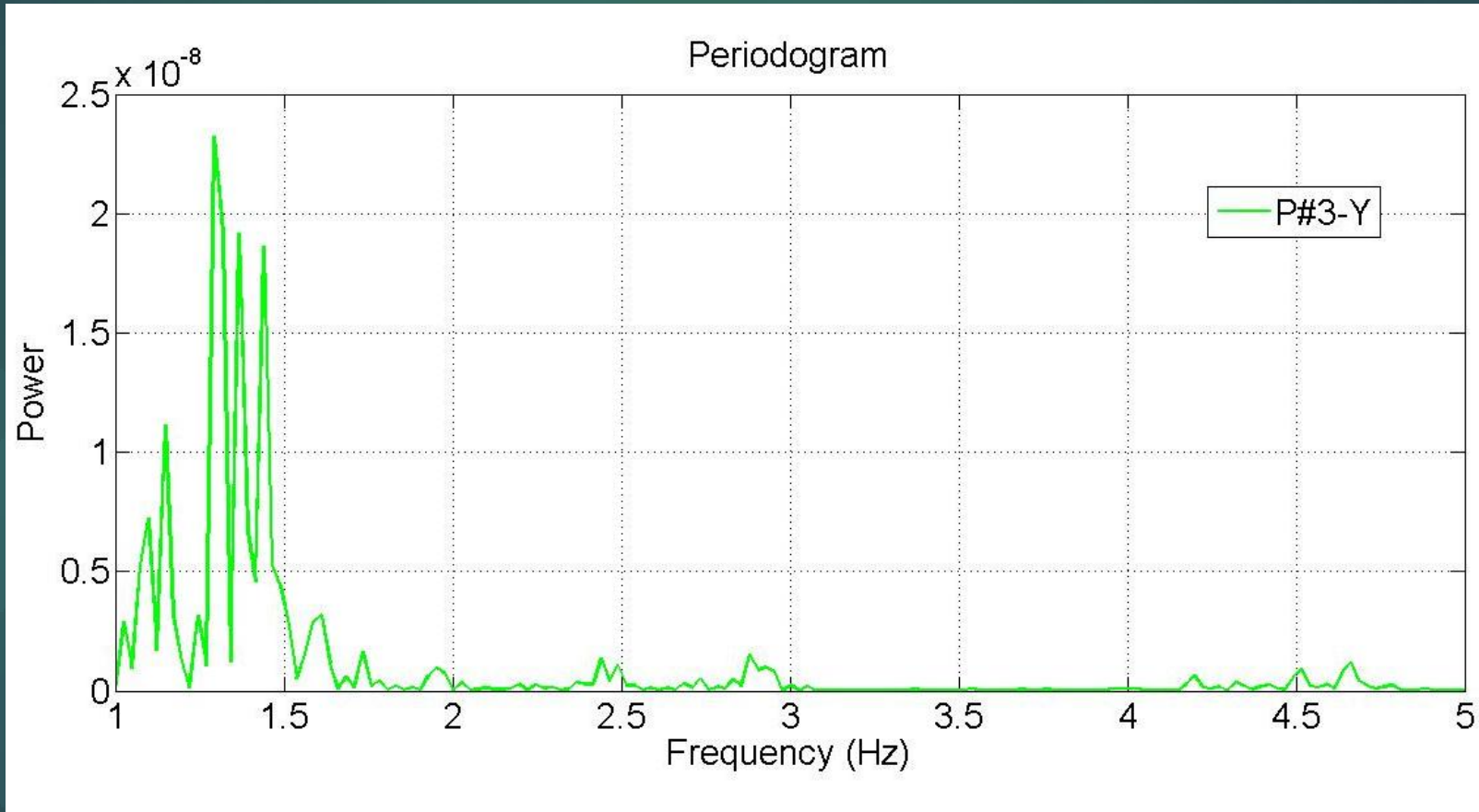

P#3 – May 12<sup>nd</sup>, 2013 @ early morning

# EXPERIMENTAL RESULTS (3)

29

## c) Peridiograms for the acceleration **along Y** (transversal axe)

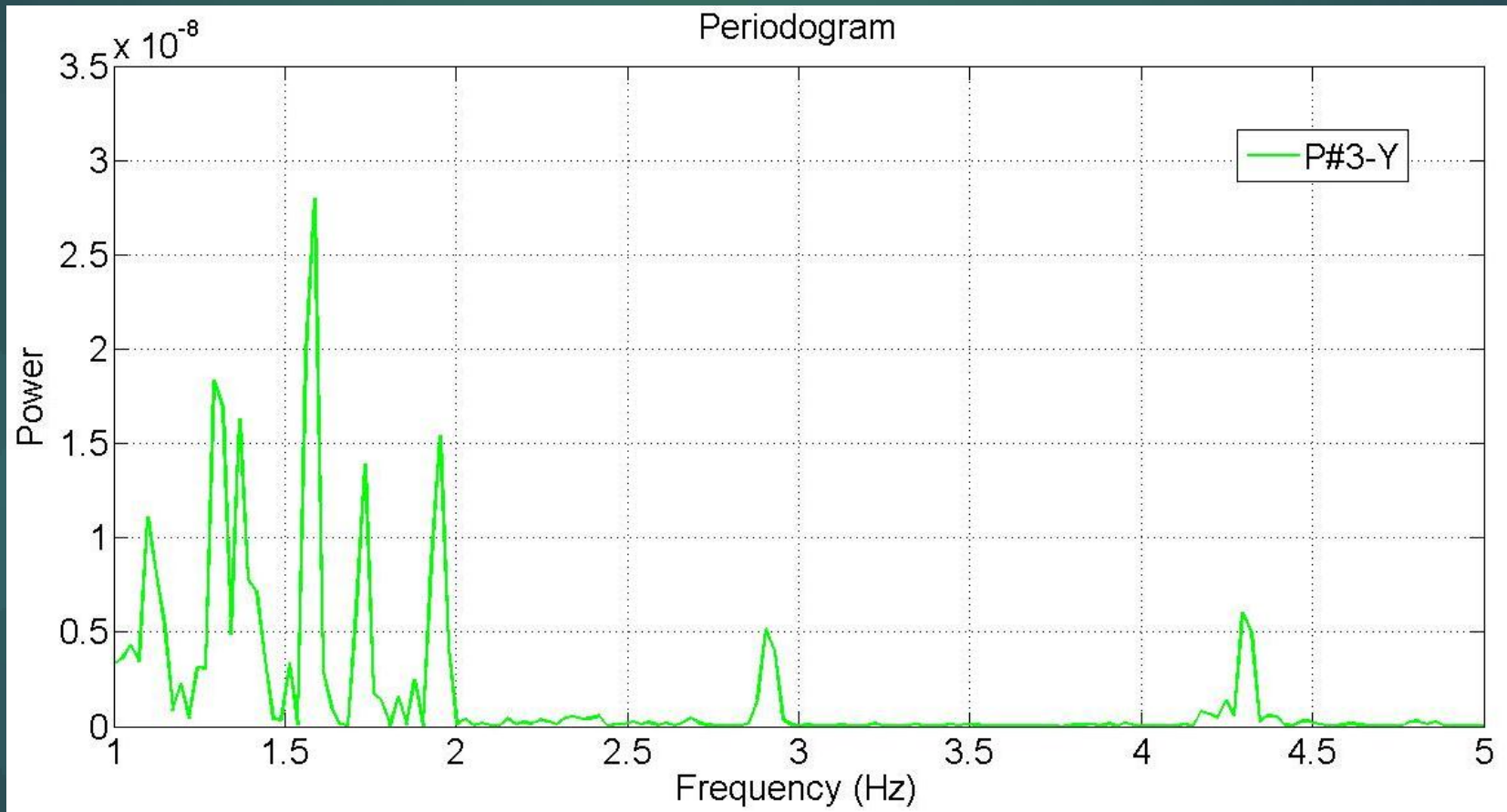

P#3 – May 12<sup>nd</sup>, 2013 @ late morning



# EXPERIMENTAL RESULTS (4)

30

a) Peridiograms for the acceleration **along Z** (vertical axe)

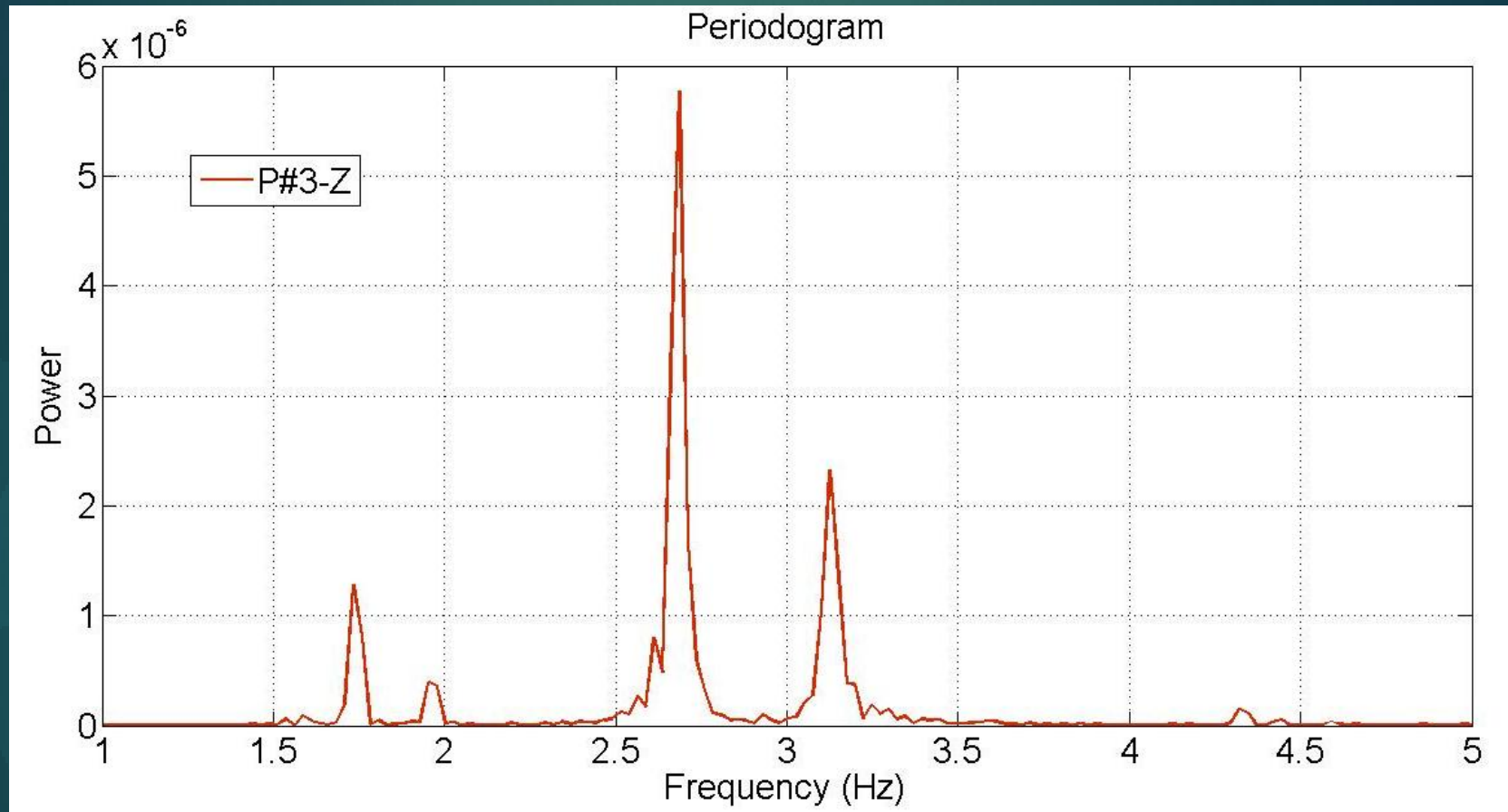

P#3 – November 30<sup>th</sup>, 2012 @ early morning

# EXPERIMENTAL RESULTS (5)

31

## b) Periodograms for the acceleration **along Z** (vertical axe)

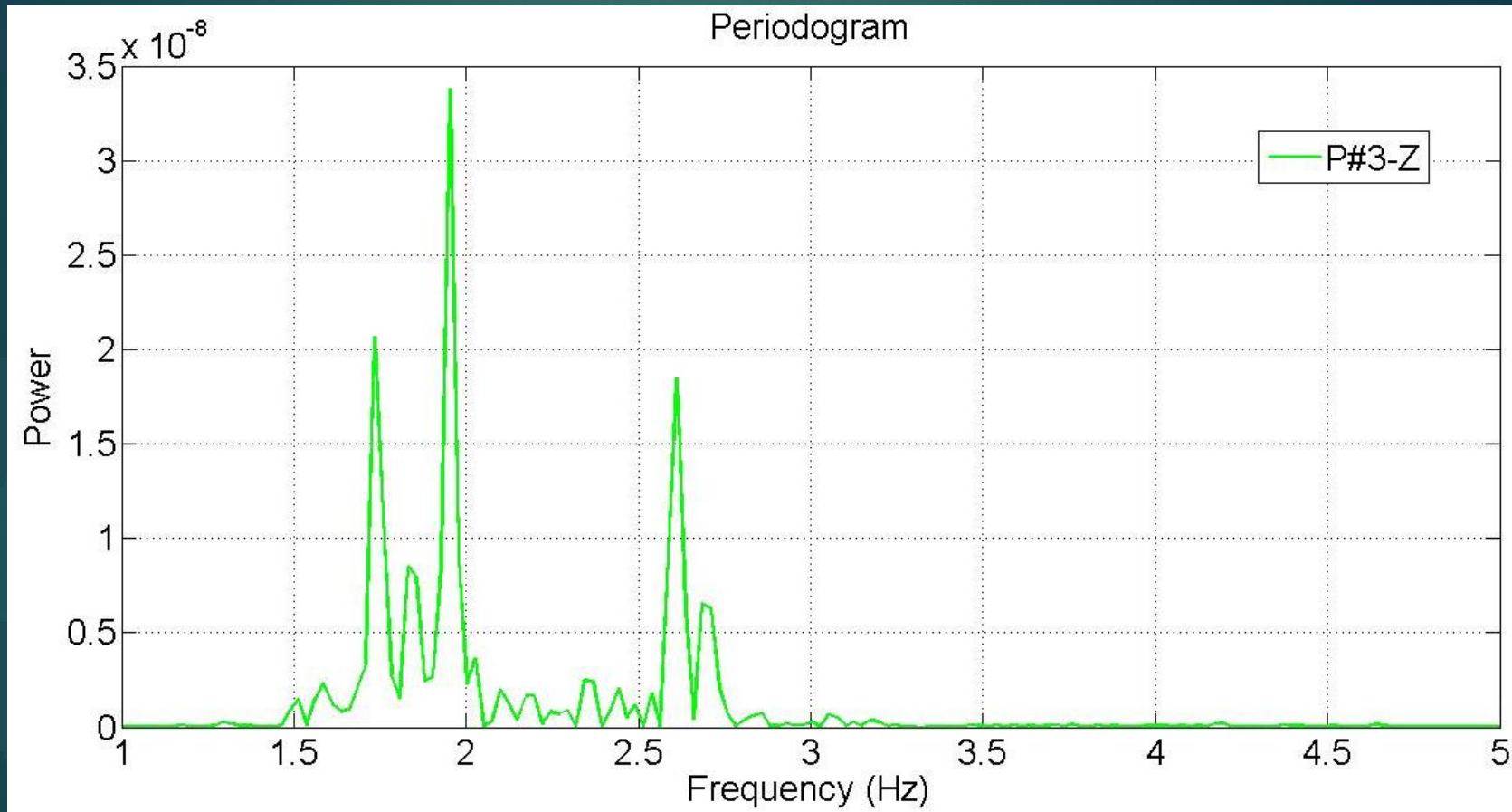

P#3 – May 12<sup>nd</sup>, 2013 @ early morning

# EXPERIMENTAL RESULTS (6)

32

## c) Peridiograms for the acceleration **along Z** (vertical axe)

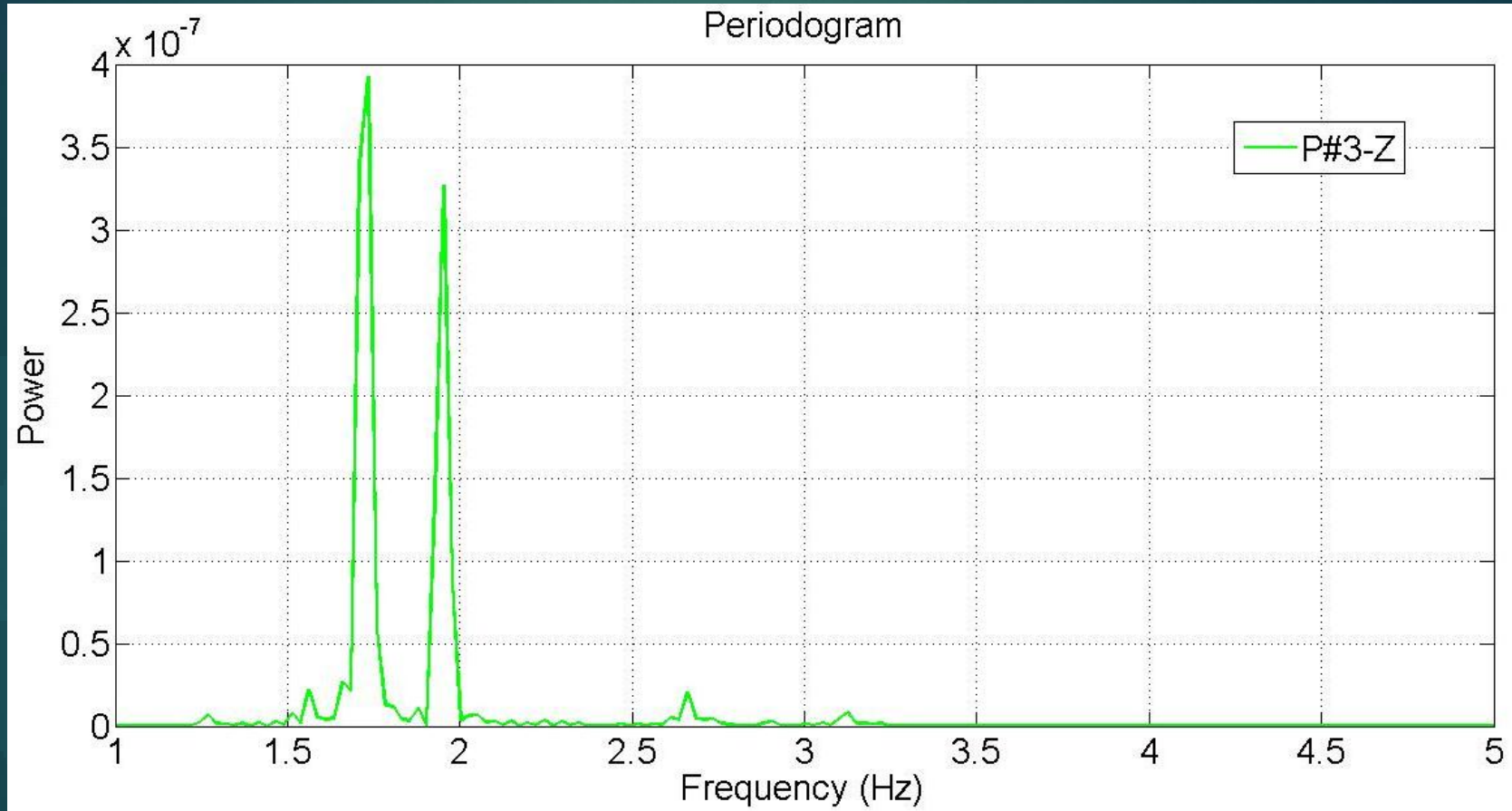

P#3 – May 12<sup>nd</sup>, 2013 @ late morning

# EXPERIMENTAL RESULTS (7)

33

Nov. 30<sup>th</sup>, 2012  
@early morning

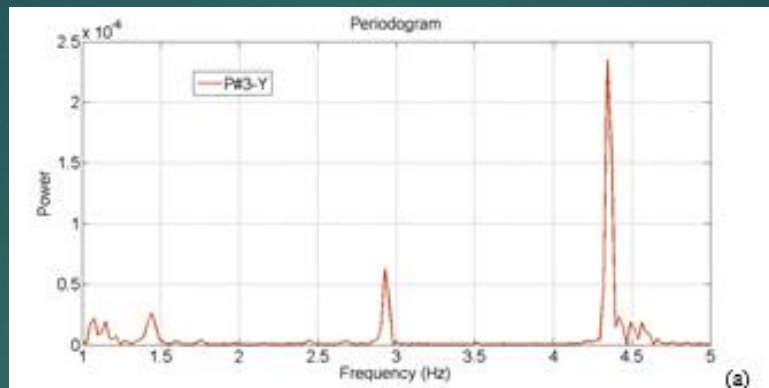

May 12<sup>nd</sup>, 2013  
@early morning

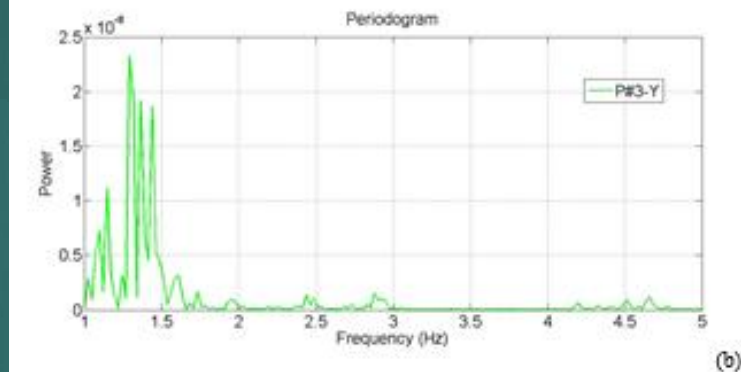

May 12<sup>nd</sup>, 2013  
@late morning

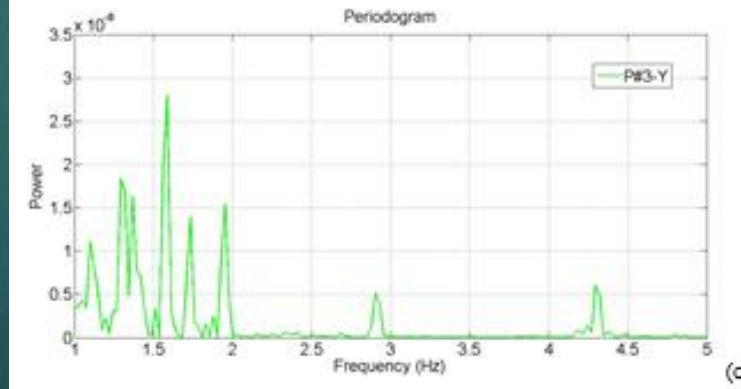

Periodograms  
comparison for the  
acceleration along Y  
(vertical axe)

# EXPERIMENTAL RESULTS (8)

34

Nov. 30<sup>th</sup>, 2012  
@early morning

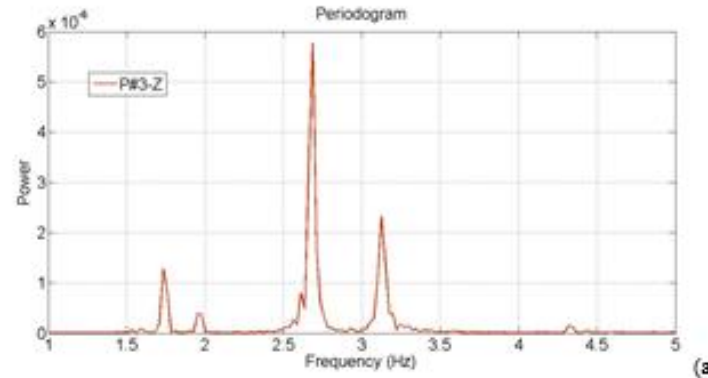

May 12<sup>nd</sup>, 2013  
@early morning

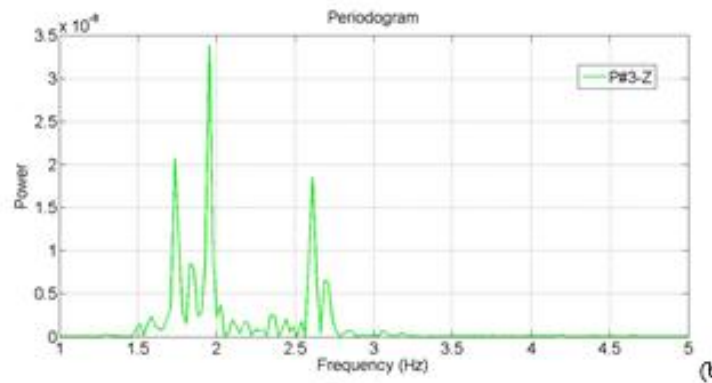

May 12<sup>nd</sup>, 2013  
@late morning

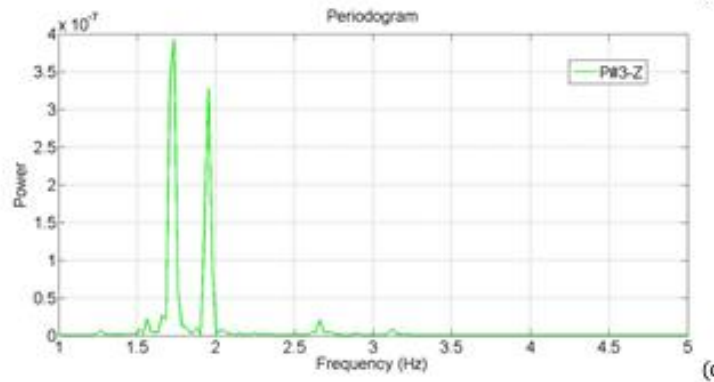

Periodiograms  
comparison for the  
acceleration along Z  
(vertical axe)



# CONCLUSIONS

35

- The **wireless structural monitoring** system adopted in these test **worked in a very satisfactory way**. Indeed standard wired solutions, applied to structures like this, would have obliged to a suitable design of the cables, with intermediate storage stations.
- Despite the two longitudinal beams realized in wood, the **structural system has a hybrid nature**, with all the antenna and the transversal links on the deck being realized in steel. The results reported in this paper confirmed by the low sensitivity of the dynamic response to temperature variations, that is, the **prevalence of the steel skeleton on determining the footbridge vibration**.

2<sup>nd</sup> INTERNATIONAL CONFERENCE

# TIMBERBRIDGES

LAS VEGAS 2013

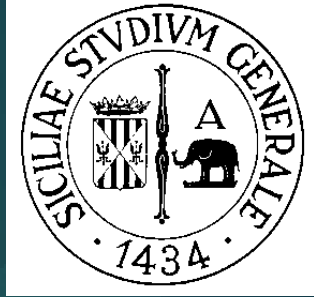

## THANKS FOR THE ATTENTION

**D. Bortoluzzi<sup>1</sup>, F. Casciati<sup>1</sup>, S. Casciati<sup>2</sup> and L. Faravelli<sup>1</sup>**

<sup>1</sup> Department of Civil Engineering and Architecture, University of Pavia, via Ferrata 1, 27100 Pavia, Italy, Tel: (+39) 0382 985459; lucia@dipmec.unipv.it; daniele.bortoluzzi@unipv.it

<sup>2</sup> Dept. DICA, Dipartimento di Ingegneria Civile e Ambientale, School of Architecture, University of Catania at Siracusa, Piazza Federico di Svevia, 96100 Siracusa, Tel.: (+39) 338 5953658 e-mail: saracasciati@msn.com