

- |                                                                                                                                                                                                                                                                                                                                                                                                                              |                                                                                                                                                                                                                                                                                                                                                                                                                                                                                                      |
|------------------------------------------------------------------------------------------------------------------------------------------------------------------------------------------------------------------------------------------------------------------------------------------------------------------------------------------------------------------------------------------------------------------------------|------------------------------------------------------------------------------------------------------------------------------------------------------------------------------------------------------------------------------------------------------------------------------------------------------------------------------------------------------------------------------------------------------------------------------------------------------------------------------------------------------|
| <ul style="list-style-type: none"> <li>1-3 Partnering articles: Jefferson piggyback; A beautiful partnership in Sioux City; Going dutch on curb ramps; Partners in the Iowa Great Lakes region</li> <li>4 Pavement maintenance: cracking and seating</li> <li>6 Safety Shorts: Written safety policies for cities and counties</li> <li>6 Iowa 1996 legislation highlights</li> <li>7 Cracking and seating survey</li> </ul> | <ul style="list-style-type: none"> <li>8 New standards for railroad pavement markings</li> <li>8 Local agencies asked to report new or modified highway-railroad signal interconnections</li> <li>10 Workshops/conferences: Bike Iowa '96; Development of Governmental Management Personnel; Maintaining Traffic Signal Systems; 2nd Annual GIS Conference</li> <li>10 CD-I training materials available for long-term loan</li> <li>11 Library materials</li> <li>12 Conference calendar</li> </ul> |
|------------------------------------------------------------------------------------------------------------------------------------------------------------------------------------------------------------------------------------------------------------------------------------------------------------------------------------------------------------------------------------------------------------------------------|------------------------------------------------------------------------------------------------------------------------------------------------------------------------------------------------------------------------------------------------------------------------------------------------------------------------------------------------------------------------------------------------------------------------------------------------------------------------------------------------------|

## The power of partnering



ADDING *-ING* TO *PARTNER* does more than turn a noun into a verb. The word *partnering* turns the whole concept of being partners into a more active, dynamic process. It's a process with numerous benefits for everyone involved.

In many of Iowa's transportation agencies, partnering is more than the latest organizational buzzword. City and county governments and transportation officials are discovering that partnering is a powerful technique for letting concerned parties help solve problems. From small projects to large,

short term to long term, Iowa transportation professionals are making partnering projects successful.

In this issue, editorial assistant Michele Regenold looks at four transportation partnering projects across the state. We hope these examples give you some ideas for enhancing cooperation among the organizations and individuals, public and private, that affect and are affected by local transportation projects. These examples demonstrate that a successful partnership is not just the end result—a rehabilitated road or beautified roadsides—but also the process itself, the give and take of partnering.

We would like to hear about your own partnering experiences. Contact Regenold, 515-296-0835. ■

### Partnering: Jefferson piggyback



A SMALL-SCALE PARTNERING PROJECT occurred in 1993 when the city of Jefferson piggybacked a 3/4-mile paving project onto a seven-mile construction job by Greene County.

Since a nearby stretch of county road E-53 (Old Highway 30) was being reconstructed, the city of Jefferson asked that the county road extension inside city limits be included. The city was able to save considerable expense by not having to contract for a paving machine for its smaller job.

This kind of neighborly project was accomplished because city and county officials had developed a good rapport. They had an informal, ongoing dialogue to discuss city and county needs. Good communication is the foundation of strong partnerships.

The Greene County engineer's office is currently working on a cooperative project with the city of Paton. ■

Jefferson Mayor Charles Davis (left) and Greene County Assistant Engineer Don VanGelder stand next to the Lincoln Highway partner paving project at Jefferson.

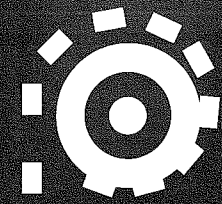
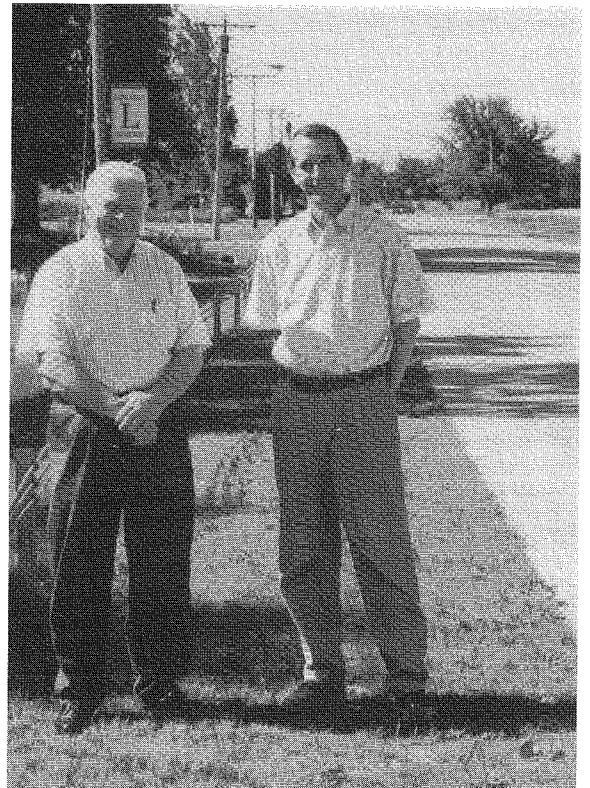

The preparation of this newsletter was financed through the Local Technical Assistance Program (LTAP). LTAP is a nationwide effort financed jointly in Iowa by the Federal Highway Administration and the Iowa Department of Transportation. Its purpose is to translate into understandable terms the latest state-of-the-art technologies in the areas of roads, bridges, and public transportation.

Subscriptions to **TECHNOLOGY NEWS** are free, and we welcome your comments, questions, and suggestions. To subscribe, or to obtain permission to reprint articles, contact the editor at the address below.

Center for Transportation  
Research and Education  
2625 N. Loop Drive, Suite 2100  
Ames, Iowa 50010-8615  
Telephone: 515-294-8103  
Fax: 515-294-0467  
BBS: 515-294-9784

Tom Maze  
Director  
(e-mail: tom@ctre.iastate.edu)

Jan Graham  
Assistant to the Director  
(e-mail: jan@ctre.iastate.edu)

Duane Smith  
Associate Director for Outreach  
(e-mail: desmith@iastate.edu)

Marcia Brink  
Editor  
(e-mail: x1brink@iastate.edu)

Ed Bigelow  
Safety Circuit Rider  
(e-mail: ed@ctre.iastate.edu)

Sharon Prochnow  
Program Coordinator  
(e-mail: sharon@ctre.iastate.edu)

Stan Ring  
Library Coordinator  
(e-mail: stan@ctre.iastate.edu)

Diane Love  
Account Clerk  
(e-mail: diane@ctre.iastate.edu)

Margaret Hammer  
Secretary  
(e-mail: margaret@ctre.iastate.edu)

The opinions, findings, or recommendations expressed here are those of the Center for Transportation Research and Education and do not necessarily reflect the views of the Federal Highway Administration or the Iowa Department of Transportation.

Iowa State University and the Center for Transportation Research and Education provide equal opportunities and comply with ADA requirements in programs and employment. Call the Affirmative Action Office at 515-294-7612 to report discrimination.

**TECHNOLOGY NEWS**  
nameplate and graphic  
elements were designed by  
Jennifer J. Reed.

## A beautiful partnership in Sioux City

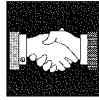

IN LATE 1994 Sioux City Mayor Bob Scott expressed his concern about the appearance of roadsides along major approaches to Sioux City to the Iowa Department of Transportation. A few months later John Cunningham, field services coordinator at the Northwest Iowa Transportation Center, heard similar comments from other city officials and the Sioux City Chamber of Commerce. They wanted the weed problem taken care of and the roadsides made to look nicer.

Cunningham says, "We asked them, 'What do you want to do?'" He and Dwight Rorholm, Transportation Center maintenance engineer with the Iowa DOT, invited Sioux City officials, Sioux City Chamber of Commerce representatives, Woodbury County Extension officials, and other interested parties, including master gardeners, to be partners with the Iowa DOT in a beautification project. They formed the Partnership for Beautification of Siouxland Highway Rights of Way.

By soliciting help from concerned groups, the Iowa DOT can make sure the changes made to the road-

sides reflected the wishes of everyone involved. A unique facet of this partnership for the Iowa DOT is that it is participating as one member of a community. It's also unique that this partnership does not involve construction, as most transportation-oriented partnerships do.

The partnership's first project took place in May 1996 along Interstate 29. Along a wall that shields motorists' views of the stockyards area, officials planted Virginia creeper, an ivy that will eventually cover the wall and enhance its appearance. Master gardeners will care for the ivy until it's well established. The Iowa DOT, which prepared the site, will seed the area with native prairie grasses.

Funding for the partnership's project has come from various sources including a joint Iowa DOT and Department of Natural Resources program and the Siouxland Initiative, a chamber of commerce group which promotes job growth. The city of Sioux City donated compost and mulch for the plants.

The partnership intends to change the look of several Siouxland highway roadsides including Interstate 29 to the South Dakota border, Iowa 12, U.S. 75, and U.S. 20. ■



Iowa DOT Director Darrel Rensink (foreground) and a master gardener from the the Partnership for Beautification of Siouxland Highway Rights of Way plant Virginia creeper that will eventually beautify a wall between Interstate 29 and the stockyards. (Photo courtesy of the *Sioux City Journal*)



Printed on  
Recycled Paper

## Going dutch on curb ramps



BEGINNING THIS YEAR the Iowa DOT will use up to \$1.5 million of the primary roads fund each year to help cities with primary road extensions (state highways) build curb ramps in accordance with the Americans with Disabilities Act (ADA).

The Iowa DOT will pay 55 percent and the cities will pay the other 45 percent of construction costs. Cities will also be responsible for preparing plans, awarding contracts, and supervising construction, according to amended Chapter 150, "Improvements and Maintenance on Primary Road Extensions," in the Iowa Administrative Code.

Cities will be selected for participation on a first-come-first-served basis. The first selection of cities began in June.

For more information, contact your area transportation center local systems engineer or Larry Jesse, urban systems engineer at the Iowa DOT, 515-239-1256. ■

## Partners in the Iowa Great Lakes region



ONE OF THE LARGER partnering projects in the state was organized in the fall of 1995 by the Iowa Department of Transportation to design the U.S. 71 highway improvement project through the Iowa Great Lakes area.

The U.S. 71 Corridor Partners include representatives from the cities of Milford, West Okoboji, Okoboji, Arnolds Park, and Spirit Lake, and from Dickinson County, as well as representatives from area economic development groups, environmental associations, the Federal Highway Administration, the Iowa DOT, recreation groups, local utilities, and construction contractors.

While the Iowa DOT usually involves local communities in highway projects through participation processes such as public hearings, it is working with over 20 organizations to complete the U.S. 71 improvements by 2001.

Since the Iowa Great Lakes area depends so heavily on summer tourism, highway construction has been a touchy subject for local residents and businesses. By involving affected parties in the planning stages, the Iowa DOT ensures that everyone who wants to have input will be heard.

One of the ways the U.S. 71 Corridor Partners are listening to people is by breaking down into smaller teams, each co-chaired by a local representative and an Iowa DOT representative. The teams are devoted to specific topics based on their members' interests including communications, beautification, local traffic management, environment, utilities and constructability, pedestrians and trails, and parking.

Sue Richter, local co-chair of the beautification team, was contacted by a community member who believes the bridge height through the Great Lakes area should be raised to accommodate vessels such as sail boats. Richter agreed to gather opinions of local marina operators on the bridge height that may be necessary in the future.

Meanwhile John Cunningham, field services coordinator for the Iowa DOT's Northwest Iowa Transportation Center and co-chair of the partnership's communications team, agreed to ask Iowa DOT officials about the potential design impact on raising the bridge height.

At a recent large group meeting of the U.S. 71 Corridor Partners, the design impact was judged to outweigh the desired height increase. The fact that the issue was explored and discussed, however, shows the partners' openness to ideas.

A public hearing on the design for the first of four segments of the U.S. 71 project, the Spirit Lake segment, will be held August 15.

An exciting recent advancement made by the partners was the establishment of a 28E Utility Board which includes the cities of Okoboji and Arnolds Park, the Great Lakes Sanitary District, and the Iowa DOT.

These organizations will work together through a 28E agreement, the cooperation of government agencies as described by the Iowa Code, to design the utility layout through the corridor. The board will be primarily concerned with water, storm sewers, and sanitary sewers. A private consultant will investigate the possibility of including private utilities.

For more information about the U.S. 71 Corridor Partners, contact John Cunningham, 712-276-1451. ■

## LTAP Advisory Committee

The people listed below help guide and direct the policies and activities of the Center for Transportation Research and Education's Local Technical Assistance Program (LTAP).

The committee meets at least annually. Representatives of rural and urban agencies and individuals concerned with the transfer of transportation technology in Iowa are welcome to attend advisory committee meetings.

Contact any of the advisory committee members to comment, make suggestions, or ask questions about any aspect of LTAP.

Roger Anderberg  
Local Systems  
Iowa Department of  
Transportation  
Telephone: 515-239-1291

Saleem Baig  
Local Systems  
Iowa Department of  
Transportation  
Telephone: 515-239-1051

Charles L. Fisher  
Superintendent of  
Public Works  
City of Spencer  
Telephone: 712-264-7220

Kevin Gilchrist  
Senior Transportation Planner  
Des Moines Metropolitan  
Planning Organization  
Telephone: 515-237-1316

Becky Hiatt  
Iowa Division, Federal  
Highway Administration  
Telephone: 515-233-7321

Raymond Holland  
City Engineer  
City of Bettendorf  
Telephone: 319-344-4055

Harold Jensen  
Story County Engineer  
Telephone: 515-382-6581

Brian Parker  
Iowa Division, Federal  
Highway Administration  
Telephone: 515-233-7315

Bob Sperry  
Webster County Engineer  
Telephone: 515-576-3281

Jim Thompson  
Transportation Director  
City of Des Moines  
Telephone: 515-283-4973



 Iowa Department  
of Transportation



Center for Transportation  
Research and Education

IOWA STATE UNIVERSITY

## Cracking and seating

*This is the second in a series of articles on pavement maintenance.*

By Michele Regenold, Editorial Assistant



ENGINEERS HAVE BEEN WRANGLING for years with the problem of reflective cracking in asphalt overlays of deteriorated portland cement concrete (PCC) pavements. No universal solution for the problem has been found. Cracking and seating is a possible solution for specific kinds of projects.

### Theory of cracking and seating

It may seem odd at first glance to actually create more cracks in the PCC you plan to overlay. More cracks in the PCC, however, may actually slow or prevent the development of reflective cracking in the asphalt overlay. Here's why.

Stress induced by traffic loads and thermal contraction of concrete slabs causes differential movement at joints and cracks. This movement causes cracks in the PCC to be "reflected" in the asphalt overlay. Cracking and seating is supposed to control or eliminate movement by reducing the size of the concrete slab. The smaller PCC pieces move less during thermal contraction. Because of the reduced movement, reflective cracking is, theoretically, delayed or eliminated.

The theory sounds good, but how well does cracking and seating perform? Does it perform well enough

to be cost effective? Studies are inconclusive and contradictory.

### Iowa research results

Three cracking and seating studies have been conducted on rural Iowa highways in Shelby County, Fremont County, and Hamilton County. Each study began in 1986 and was completed in 1993. While not definitive in their conclusions, the studies offer some insight about the effects of cracking and seating on Iowa roads.

In each study, cracking and seating delayed or reduced reflective cracking in the test sections compared with the control sections. Some structural value was lost due to the crack and seat process. Cracked slab pieces in the size range of 60 to 90 cm (2 to 3 ft) seem most effective, but the environment, age of the pavement, and traffic volumes are all factors in determining the best slab size for a given project. Gary Harris, formerly the secondary road research coordinator at the Iowa Department of Transportation, who wrote two of the three final reports, determined that a minimum asphalt overlay thickness of 10 cm (4 in) worked best.

### Recommendations from NAPA

The National Asphalt Pavement Association (NAPA) conducted national surveys of state highway agencies in 1986 and 1988 about cracking and seating activities and developed some general guidelines for the technique. Before beginning the cracking process, NAPA suggests rectifying any drainage problems.

Construction joints are another area of concern; they often reflect through the overlay faster than cracks. NAPA suggests inspecting them before beginning the crack and seat process. Badly deteriorated joints may be a sign of voids beneath the joint, which may require remedial action. It's also important to mark the positions of culverts, ducts, and drainage pipes so workers can avoid direct cracking over them.

NAPA points out that the crack pattern is affected by several factors, including the type of impact equipment, the energy of the impact, the slab temperature, inherent stresses in the slab, and subgrade conditions. Proper cracking techniques cause fine cracks that permeate through the depth of the slab. To make sure the procedure is effective, the crack-



Ten years later: a look at a test section in the Hamilton County cracking and seating study. (Photo by Michele Regenold)

CRACKING AND SEATING . . . continued on page 5

ing pattern should be checked frequently. Continuous longitudinal cracks tend to reflect through asphalt overlays, so those kinds of cracks should be avoided.

In terms of size of cracked pieces, NAPA found no definite design dimensions in their survey. Based on numerous states' experiences, NAPA concluded the most effective size range was 45 to 90 cm (1.5 to 3 ft), which is close to the Iowa finding of 60 to 90 cm (2 to 3 ft). NAPA also concludes that three- to four-foot intervals for transverse cracking are effective.

Once the PCC slab is cracked, the pieces should be seated firmly against the subgrade. The most effective seating is accomplished with a heavy pneumatic-tired roller. If the pieces aren't seated properly, they may rock beneath the overlay and cause reflective cracking. Overseating the cracked pieces could loosen them, which may cause differential movement under traffic loads, subsequently causing reflective cracking.

#### Cracking and seating in Cedar Falls

Ron Arends, senior engineer in Cedar Falls, says his department has been doing cracking and seating on urban projects since 1991. When they started, no information was available except for research done on rural highway projects. After considerable trial and error, the city of Cedar Falls has developed some helpful, informal guidelines that other city engineers are taking note of.

Good candidates for cracking and seating, says Arends, are pavements that still have a good profile and a good curb line. The pavement should have low to moderate longitudinal cracking with some "D" cracking, but "D" cracking should not be too severe. If "D" cracking is severe, clean the joints and apply an asphalt patch prior to the overlay. He hates to see excessive faulting or settling in the pavement, however, because that indicates subgrade problems that are not easily fixed.

Cracking and seating works best where there is not a subgrade moisture problem. Where there has been excessive subgrade moisture, Arends reports that cracking and seating hasn't worked well unless the area was drained first. The additional cost to correct drainage problems using a subdrain system is about \$7 per lineal foot for one side of the roadway. This amount is in addition to the \$40–50 cost per lineal foot for the whole process, including the overlay.

Before cracking begins, a full-depth saw cut at two to three feet from the curb face is made to isolate the curb. Other cities have tried cracking the pavement without isolating the curb first and had cracks develop in the curb. Although isolating the curb and gutter takes extra time, one benefit is that it helps keep the cracked pieces interlocked inside a sort of frame.

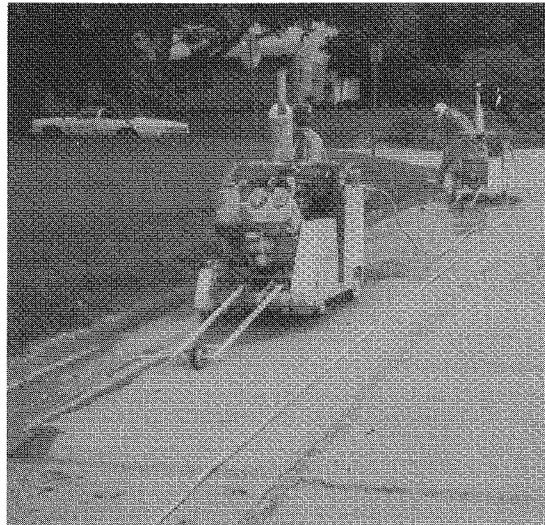

A worker saws to isolate the curb from the rest of the street. (Photo courtesy of Ron Arends, senior engineer, Cedar Falls)

Arends says that water lines are typically deep enough to prevent damage from the cracking process. To avoid shallow storm sewers and old cast iron gas mains, workers mark them with paint. Arends also suggests isolating manholes with a four- to five-foot radius, and skipping water and gas valves and box culverts.

Despite the deep vibrations caused by the cracking process, the city has received no complaints from adjacent businesses. Even working within eight feet of a huge plate glass window caused nothing more severe than some shimmying glass. Naturally, residents aren't quite so easygoing when their pictures rattle against the walls. Sending a courtesy letter before work begins, explaining the procedure, can help alleviate concerns.

During cracking, the pavement is struck every 18 to 24 inches. Arends says they have experimented with seating the cracked pavement of residential streets with 35-ton rollers but have switched to using 50-ton, single-axle rollers on all their streets.



*Editor's note: Ed Bigelow has recovered nicely from knee surgery and is back at CTRE conducting workshops and generally making life safer for Iowa's local roads personnel.*

## Written safety policies for cities and counties

By Ed Bigelow, Safety Circuit Rider

ALL CITIES AND COUNTIES in Iowa should develop written safety policies. These policies promote the safety of your employees as well as the traveling public.

A general safety policy simply states that the city or county will follow all rules and regulations required by the Occupational Safety and Health Administration (OSHA) and the Iowa Code.

The appropriate governing body (the city council or county board of supervisors) should enact the general safety policy to cover all departments. Then each department should develop written policies and work rules to meet its particular needs.

If you head a street or road department and your council or board has not approved a general policy to cover all departments, ask the council or board to

approve a general policy for your road department. A general road department safety policy will support your development of specific work rules, safety training programs, safety committee activities, and specific safety policies for your road department.

An example of a specific written safety policy is one for snow and ice removal—and fall is the perfect time to develop such a policy, or review and update the one you have.

In liability cases involving snow and ice removal, Iowa judges determine whether your city or county followed its policy. If your records show you did, your taxpayers may save money from damage claims and your insurance company may continue to provide you with liability insurance.

Your written safety policy for snow and ice removal can save the reputations of you and your equipment operators. Your leadership can make the difference! ■

## Iowa 1996 legislation highlights

By Michele Regenold, Editorial Assistant



Following are highlights from the 1996 session of the Iowa legislature that affect local transportation agencies.

### Blue Ribbon Task Force recommendations

In the February 1996 issue of *Technology News*, we gave you an overview of the recommendations made by the 1995 Blue Ribbon Transportation Task Force in its report on Iowa's state and local highway transportation budgets. Here are some recommendations that made it through the 1996 legislature:

Section 28E.20 was repealed from the Iowa Code. Under this section, before a local agency could purchase new equipment it had to evaluate the possibility of sharing the equipment with another agency. Originally designed to encourage interagency sharing, this section instead had become a time-consuming, costly burden for local governments.

The other task force recommendations that were approved by the legislature deal with funding sources for the Road Use Tax Fund (RUTF). The task force recommended that off-the-top diversions

from the RUTF be reevaluated. Governor Branstad approved moving the \$1 million appropriation for recreational trails out of the RUTF; however, he vetoed moving to the general fund the Iowa Department of Transportation's indirect costs, like staff and personnel. Governor Branstad also signed into law a bill crediting overweight truck fines and truck safety fines to the RUTF.

A Senate resolution requesting a study of sharing and leasing government equipment may also be related to a Blue Ribbon Task Force recommendation, which suggested assessing the possibility of leasing the Iowa DOT's fleet.

### Other new legislation

In cooperation with landowners, counties will be allowed to restrict public access to certain Level B (dirt) roads by reclassifying them as Level C roads. The purpose of the new law is to reduce the damage done to dirt roads by recreational drivers and still protect the access needs of those who own or farm the land adjacent to these roads. ■

With all that punishment to the pavement, how much structural capacity is lost? Since it can vary from street to street, Arends doesn't want to assign a specific amount of structural loss due to cracking and seating. Instead he says the city does a structural analysis for every pavement. Any soft areas are typically repaired with a full-depth asphalt patch.

The overlay depth varies depending on the kind of street. For residential streets, they place a three-inch overlay, for collector streets, a four-inch overlay, and for some streets as much as a five- and even a six-inch overlay is placed.

Overall Arends says the city of Cedar Falls is very happy with how cracking and seating performs. He believes that the asphalt seems to maintain a better profile over time and reflective cracking is limited. Consequently maintenance costs are down and the ride is better.

For more information about cracking and seating in Cedar Falls, contact Ron Arends, 319-273-8606. For more information about the special considerations when cracking mesh-reinforced concrete, contact Jim Cable, associate professor of civil and construction engineering at Iowa State University, 515-294-2862.

To borrow the Iowa research studies or the NAPA publication on cracking and seating, contact Stan Ring, CTRE librarian, 515-294-9481. ■

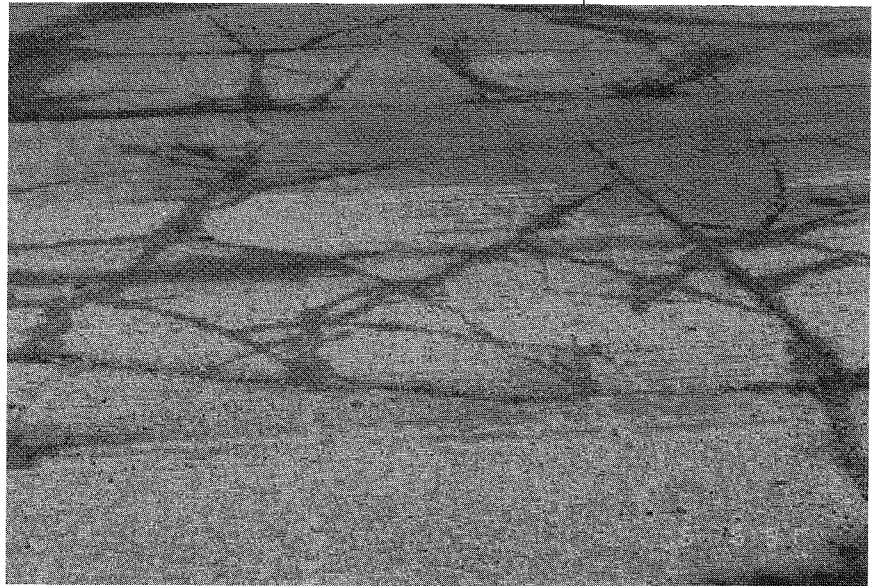

The cracking pattern shows up by wetting the pavement. As the pavement dries, the cracks remain wet and visible. (Photo courtesy of Ron Arends, senior engineer, Cedar Falls)

## Cracking and seating survey results

IN MAY 1996 we sent informal surveys to 180 city and county engineers in Iowa to solicit their views on cracking and seating. Forty-seven percent of the surveys were returned, indicating a serious interest in the subject.

The question asking for opinions about the relative effectiveness of cracking and seating as a method of rehabilitating pavement provoked several comments. One respondent wrote beside his answer that he had "no first hand opinion" but "based on seminars about the process" he thought cracking and seating was in the range between "somewhat effective" and "effective" at reducing reflective cracking.

The question asking whether cracking and seating is a cost-effective method of rehabilitating pavement provoked considerable comment, too. Among respondents who have used cracking and seating, the majority, 64 percent, believe it is cost effective. Of the 32 percent who believe it is not effective, some explained that after two or three years, there

was still little reflective cracking but the joints were already showing.

Nearly 40 percent of those without cracking and seating experience declined to answer the question about cost effectiveness. One person wrote, "Each project needs to be considered on its own merits. We did not think it cost effective on the project we considered." Another respondent marked "yes" for rural slabs and "no" for urban slabs with the comment that "a 4 to 5 inch overlay would end up causing drainage problems."

Some of the survey respondents identified themselves. The following cities have used cracking and seating at least once: Cedar Falls, Creston, Denison, Des Moines, Marion, Waterloo, and for the first time this year, Independence. Counties that have used cracking and seating include Chickasaw, Clinton, Delaware, Montgomery, Ringgold, Scott, and for the first time this year, Benton. ■

## Results in brief

Total number of respondents =  
85/180 or 47% (all numbers rounded)

A 22/85 (26%) have tried C & S

B 63/85 (73%) have not tried C & S

	A%	B%
1) Opinion of C & S as way of reducing reflective cracking		
effective	37	19
somewhat effective	18	49
not effective	36	2
no response	9	30
2) Is C & S cost effective?		
yes	64	40
no	32	25
no response	4	35
3) Would you use C&S again or do you intend to try it?		
yes	50	21
no	27	17
maybe		60
no response	23	2

## New standards for railroad crossing pavement markings

Thanks to Walt McDonald, special projects coordinator at the Iowa Department of Transportation, for the articles on this page regarding railroad crossings.



EFFECTIVE JUNE 12, 1996, 761 IAC 130.1(3) amends Iowa adoption of the Manual on Uniform Traffic Control

Devices for streets and highways (MUTCD) as the Iowa standard for pavement markings in advance of a highway-railroad grade crossing.

New national standards will be incorporated into the next issue of the MUTCD. In the meantime, until the MUTCD is republished and adopted by Iowa, MUTCD Part VIII, Section 8B-4 of the 1988 edition is superseded by this IAC provision.

The new pavement marking standard provides a more cost effective, durable, and visible pavement marking because it will fit between the normal wheel tracks. The revised standard applies to future painting or repainting of pavement markings.

If you have any questions on these markings, contact Dwight Stevens, director, of the Iowa Department of Transportation Office of Traffic Engineering, 515-239-1513, or Steve Gent, Iowa DOT traffic operations engineer, 515-239-1129.

130.1(3) The following replaces Part VIII, Section 8B-4, of the 1988 edition of the "Manual on Uniform Traffic Control Devices for Streets and Highways":

a. Pavement markings in advance of a highway-railroad grade crossing shall consist of an X, the letters RR, a no passing zone line, and certain transverse lines.

All markings shall be reflectorized white except for the no passing zone line which shall be placed in each lane on all paved approaches to crossings where crossing signals or automatic gates are located or where the prevailing speed of highway traffic is 40 miles per hour or greater.

(1) Pavement markings shall be placed at crossings where continuous rails are in place, regardless of whether the railroad is operating.

(2) Markings need not be placed if any portion of the rails in the roadway has been removed or paved over, if any portion of the rails approaching the crossing has been removed, or if EXEMPT signs are in place.

(3) At minor crossings or in urban areas, pavement markings may be omitted if an engineering study indicates that other devices installed provide suitable warning.

b. The design of pavement markings at highway-railroad grade crossings shall be as illustrated in the following diagrams:

(see diagrams on page 9)

## Local agencies asked to report new or modified highway-railroad signal interconnections



THE IOWA DEPARTMENT OF TRANSPORTATION wants to make sure Iowans never experience a tragedy like Chicago's school bus/train collision in October 1995.

In that accident, the bus didn't have time to clear the tracks after the railroad signal system overrode the traffic signal system at the grade crossing. Seven students died, and everyone else on board was injured.

The Iowa DOT has been working closely with local governments and railroads to evaluate all grade crossings in Iowa that have interconnected signal systems. The department is happy to help local agencies evaluate interconnections in their jurisdictions.

Currently, information about such interconnections is not included in the U.S. DOT Federal Railroad Administration Highway-Railroad Grade Crossing Inventory. Until it is, the Iowa DOT is

asking local governments to report any *new or modified* interconnects (by FRA crossing number) to the Iowa DOT. The department will compile the data and make them available to the FRA.

Please send information about new or modified interconnects to

Richard Brown, Manager, Rail Crossing Safety Funds  
Office of Maintenance Programs  
Iowa Department of Transportation  
800 Lincoln Way  
Ames, IA 50010  
(voice) 515-239-1511; (fax) 515-239-1005  
(e-mail) brown@iadot.e-mail.com

For help with technical issues regarding railroad/traffic signal interconnects, contact Tim Crouch, Iowa DOT traffic analysis engineer, (voice) 515-239-1545. ■



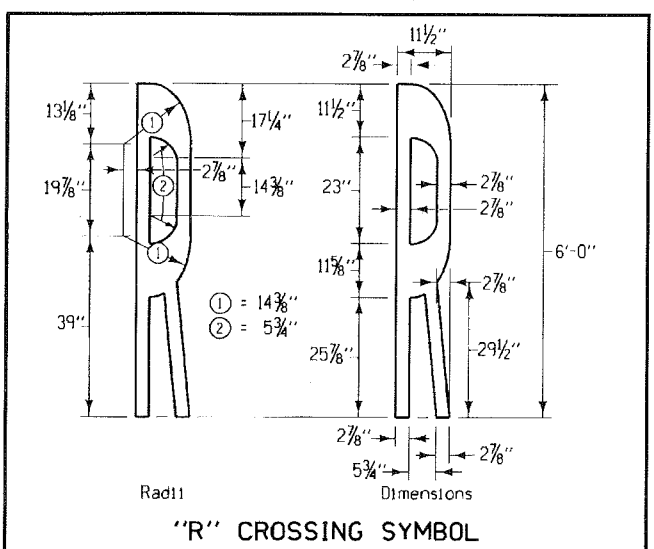
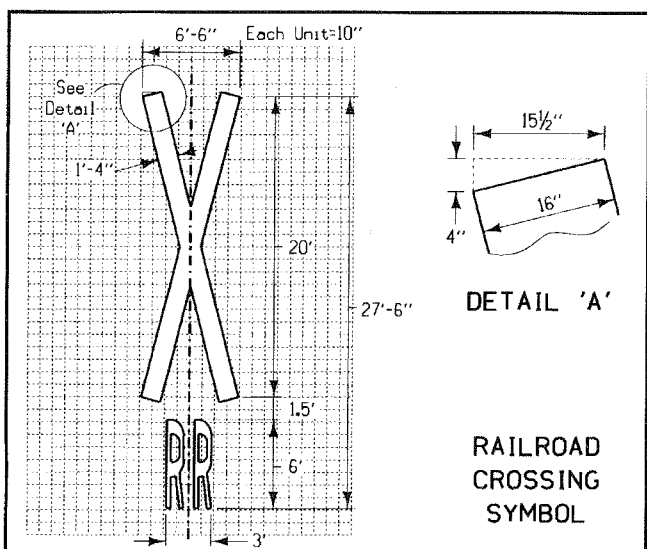
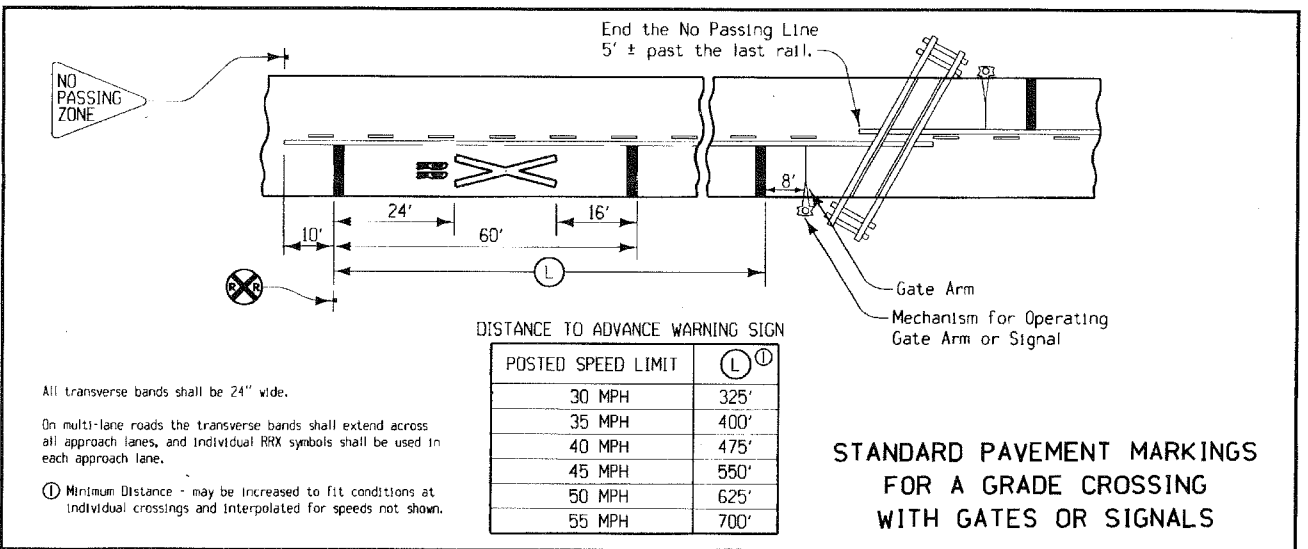
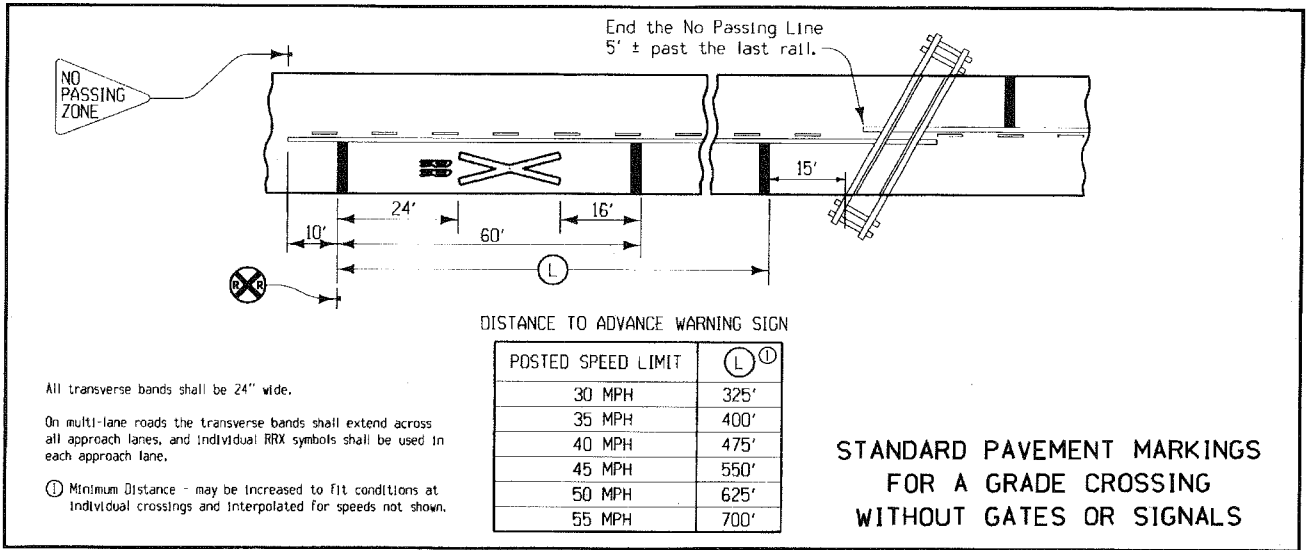

New specifications for railroad crossing roadway markings will be less expensive to paint and will wear longer because the narrower markings will fit between wheel paths.

## Iowa's 2nd annual GIS conference

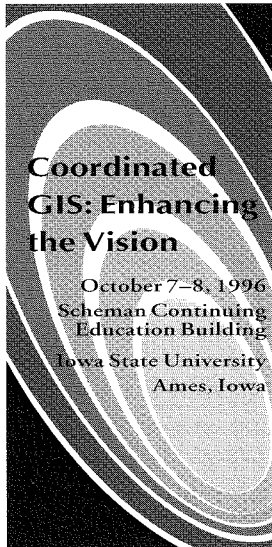

The Iowa Geographic Information Council is sponsoring Iowa's second annual conference on Geographic Information Systems in Ames on October 7 and 8, 1996.

Plans for this year's conference include a "vendor bake-off," concurrent sessions for new and experienced users of GIS platforms, showcases of GIS applications in Iowa, and much more.

Contact Reg Souleyrette, conference chair: (voice) 515-294-8103; (e-mail) [reg@iastate.edu](mailto:reg@iastate.edu) ■

## New CTRE-sponsored workshops

By Josh Murphy, Editorial Assistant

THIS SUMMER AND FALL, look for three new CTRE-sponsored or co-sponsored workshops. For more information contact Duane Smith, associate director for outreach, 515-294-8103.

### **Bike Iowa '96** **August 8, 1996** **August 9-10, 1996** **Cedar Falls/Waterloo, Iowa**

This combined workshop/conference is for bicycle and pedestrian professionals; bicycle, pedestrian, and trail advocates; transportation staff and officials; planners; engineers; architects and landscape architects; and other interested persons.

On August 8, the Bicycle Federation of America will conduct a bicycle and pedestrian design workshop for persons involved in planning and designing facilities.

On August 9-10, a conference will share information and promote communication about a variety of issues that affect bicyclists and pedestrians in Iowa. Topics include facility design and maintenance, safety, education, networking, liability, and funding. A goal of the conference is to share information and improve working relationships between planners and users of bicycle facilities.

You can register for either the workshop, the conference, or both. The workshop/conference is sponsored by the Iowa Department of Transportation, the Center for Transportation Research and Education, the Iowa Natural Heritage Foundation, the League of Iowa Bicyclists, and the Federal Highway Administration.

### **Development of Governmental Management Personnel** **September 24, 1996** **Ames, Iowa**

This one-day CTRE-sponsored seminar is for first-line supervisors (foremen) who interface with labor and management. Carl P. Johnson, a management consultant and owner of C.P. Johnson and Associates, will conduct the seminar. Specifically, he will cover the following topics:

- Changing managerial roles
- Manager as leader
- Managing through goal setting
- Time management
- Creating a problem-solving environment
- Dealing with negative behavior

### **Maintaining Traffic Signal Systems** **October 16-17, 1996** **Ames, Iowa**

This two-day CTRE-sponsored workshop is for municipal, state, or federal personnel who maintain and repair traffic signal systems. The workshop will provide professional and practical information about constructing, operating, and managing traffic signal systems.

The workshop will cover operation of control cabinets; methods to maintain and fix traffic signal systems; and factors to consider when purchasing, installing, and maintaining traffic signal equipment. ■

## Local agencies like interactive CDs for in-house training

Iowa's transportation agencies are enthusiastic about CTRE's CD-I (compact disk interactive) players and training CDs. Sharon O'Hearn, maintenance supervisor at the Iowa DOT's Fort Dodge garage, liked the winter road maintenance CD so much that she recommended it to Iowa DOT's Maintenance Division. As a result, the program is being incorporated as a central component of the department's snow and ice removal training for Iowa DOT shops.

Michael Raner, safety director for the Northwest Iowa Planning and Development Commission, has used the CD-I training with groups

and "loved it." It's an effective change from other kinds of training materials, he says.

CTRE has five CD-I players available for long-term (one- or two-month renewable) loan. The players come with the CD(s) of your choice ("Snow and Ice Control" or "Traffic Control in Construction Work Areas"), along with simple instructions for using the equipment for in-house, individualized training.

To borrow a player, contact Stan Ring, librarian, 515-294-9481.

FOLLOWING IS A SAMPLING of new or popular materials available from the CTRE library. To obtain materials or a catalog of library materials, contact Stan Ring, library coordinator, Monday, Wednesday, and Friday mornings at 515-294-9481. Or use this page as an order form. Check the box next to the materials you want and return this form to the Center for Transportation Research and Education, ISU Research Park, 2625 N. Loop Drive, Suite 2100, Ames, Iowa 50010-8615. (Please limit your request to four items.)

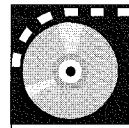

**library materials**

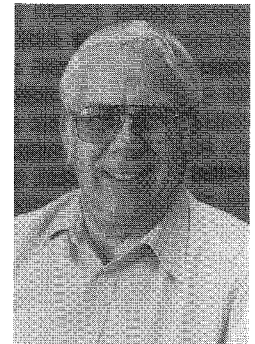
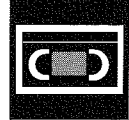

Stan Ring, library coordinator

**Publications**

**Manual of Practice for an Effective Anti-Icing Program** (USDOT-FHWA-RD-95-202) 70 pages.

This manual guides maintenance managers in developing a systematic and efficient anti-icing program. It recommends specific practices and guides operations. Free copies.

Request # P1174

**Maintenance Practices for Local Roads** (Penn-DOT-FHWA-DOT-PA-94-0200) 698 pages.

This four-volume publication includes suggestions for maintenance techniques, personnel supervision, and program administration and an overview for elected officials. Loan copy.

Request # P1176

**Semisesquicentennial Transportation Conference Proceedings 1996** (Center for Transportation Research and Education) 224 pages.

The 57 papers presented at this conference in Ames on May 13-14, 1996, are included. Papers cover many of today's critical transportation issues. Loan copies.

Request # P1178

**Fly Ash Facts for Highway Engineers** (ACAA-USDOT-FHWA-SA-94-081, 1995).

This publication provides technical information about the engineering applications of fly ash, including PCC pavement bases, grout, fast-track paving, and embankments. It replaces a 1986 publication. Free copy.

Request # P1187

**Videotapes**

**Chip Seal Application** (US-DOT-FHWA, 1995) 40:00 min.

This videotape describes the road surface sealing operation of one or more applications of liquid asphalt and aggregate to provide a waterproof and skid-resistant surface. The entire operation is covered in detail in three parts. Loan copy.

Request # V448

**Asphalt Paving Inspection** (LTAP, 1995) 59:00 min.

This videotape provides detailed information regarding preliminary responsibilities, paving operations, and problems. Loan copy.

Request # V458

**Trench Emergency** (Coastal, 1996) 16:00 min.

This new videotape reviews the *dos* and *don'ts* of trench rescue and can save the lives of both the trapped person and the rescuer. It covers the dangers posed by trenches and shoring and shielding, and examines an actual cave-in and explains what to do while waiting for the rescue team. A 20-page handbook is included. Loan copy.

Request # V462

**Snow Plow Safety** (National Safety Council, 1995) 23:00 min.

This videotape is for new snow plow operators or as a refresher for experienced operators. Topics addressed are equipment inspection, positioning the truck, scanning, mirror use, and defensive driving. Loan copy.

Request # V463

**Understanding Superpave Mix Design** (USDOT-FHWA, 1996) 13:10 min.

This videotape provides a brief overview and explanation of the new SHRP design for hot mix asphalt pavements. This system is to be fully implemented by the year 2000. Loan copy.

Request # V460

Name \_\_\_\_\_  
 Address \_\_\_\_\_  
 City/State/Zip \_\_\_\_\_  
 Phone \_\_\_\_\_

Please send a complete catalog of all publications and audiovisual materials available from your office.

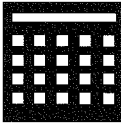

**August 1996**

6	Motor Grader Operator Training	Cedar Rapids	Sharon Prochnow, 515-294-8103
6-7	Multistate RWIS	Council Bluffs	Duane Smith, 515-294-8103
8-10	Bike Iowa '96	Waterloo	Duane Smith, 515-294-8103
22	Fundamentals of Water Treatment	Creston	Steve Jones, 515-294-3957
23	Fundamentals of Water Treatment	Cherokee	Connie Middleton, 515-294-6229
24-29	APWA National Congress and Exposition	Washington, D.C.	Duane Smith, 515-294-8103

**September 1996**

9	Growth Management Workshop	Des Moines	Tom Maze, 515-294-8103
10-11	APWA Fall Conference	Newton	Duane Smith, 515-294-8103
12-14	Iowa Section ASCE Annual Meeting	Iowa City	Christy Collicott, 515-622-2610
17	Maintaining Pavements	Eastern Iowa	Duane Smith, 515-294-8103
24	Development of Governmental Management Personnel	Ames	Sharon Prochnow, 515-294-8103
25-26	Iowa Secondary Roads Maintenance Supervisors Association Annual Conference	Ames	Duane Smith, 515-294-8103

**October 1996**

2-3	APWA Snow Plow Rodeo	Des Moines	Duane Smith, 515-294-8103
7-8	Iowa Annual GIS Conference	Ames	Sharon Prochnow, 515-294-8103
8	Maintaining Pavements	Central Iowa	Duane Smith, 515-294-8103
15-16	Iowa Section ASCE/ICEA Surveying Conference	Ames	Don Wall, 515-294-3811
16-17	Traffic Signal Maintenance and Management	Ames	Duane Smith, 515-294-8103
24-25	ITCSA Fall Conference	Newton	Don Wall, 515-294-3811

**November 1996**

6	Iowa Section ASCE Transportation Conference	Ames	Don Wall, 515-294-3811
7	Better Concrete Conference	Ames	Jim Cable, 515-294-2862
10-14	ASCE 1996 Annual Convention and Exposition	Washington, D.C.	ASCE, 703-295-6000
14	Bridge Design Considerations	Ames	Jim Cable, 515-294-2862
18	Iowa Section ASCE Structural Design Conference	Ames	Don Wall, 515-294-3811
20-22	ISAC Fall Conference	Des Moines	Jerri Noboa, 515-244-7181

**December 1996**

3-5	Iowa County Engineers Conference	Ames	Jim Cable, 515-294-2862
-----	----------------------------------	------	-------------------------

**P486-0524**

**TECHNOLOGY NEWS**

Center for Transportation  
Research and Education  
ISU Research Park  
2625 N. Loop Drive, Suite 2100  
Ames, IA 50010-8615

DO NOT FORWARD  
ADDRESS CORRECTION REQUESTED  
RETURN POSTAGE GUARANTEED