F. W. Klaiber, D. J. White, T. J. Wipf, B. M. Phares, V. W. Robbins

**Development of Abutment Design Standards for
Local Bridge Designs
Volume 1 of 3**

Development of Design Methodology

August 2004

Sponsored by the
Iowa Department of Transportation
Highway Division and the
Iowa Highway Research Board



Iowa DOT Project TR - 486

Final

REPORT

IOWA STATE UNIVERSITY
OF SCIENCE AND TECHNOLOGY

**Department of Civil, Construction and Environmental
Engineering**

The opinions, findings, and conclusions expressed in this publication are those of the authors and not necessarily those of the Iowa Department of Transportation.

F. W. Klaiber, D. J. White, T. J. Wipf, B. M. Phares, V. W. Robbins

Development of Abutment Design Standards for Local Bridges Bridge Designs Volume 1 of 3

Development of Design Methodology

August 2004

Sponsored by the
Iowa Department of Transportation
Highway Division and the
Iowa Highway Research Board

Iowa DOT Project TR - 486

Final

REPORT

IOWA STATE UNIVERSITY
OF SCIENCE AND TECHNOLOGY



**Iowa Department
of Transportation**

**Department of Civil, Construction and Environmental
Engineering**

ABSTRACT

Several superstructure design methodologies have been developed for low volume road bridges by the Iowa State University Bridge Engineering Center. However, to date no standard abutment designs have been developed. Thus, there was a need to establish an easy to use design methodology in addition to generating generic abutment standards and other design aids for the more common substructure systems used in Iowa.

The final report for this project consists of three volumes. The first volume (this volume) summarizes the research completed in this project. A survey of the Iowa County Engineers was conducted from which it was determined that while most counties use similar types of abutments, only 17 percent use some type of standard abutment designs or plans. A literature review revealed several possible alternative abutment systems for future use on low volume road bridges in addition to two separate substructure lateral load analysis methods. These consisted of a linear and a non-linear method. The linear analysis method was used for this project due to its relative simplicity and the relative accuracy of the maximum pile moment when compared to values obtained from the more complex non-linear analysis method. The resulting design methodology was developed for single span stub abutments supported on steel or timber piles with a bridge span length ranging from 20 to 90 ft and roadway widths of 24 and 30 ft. However, other roadway widths can be designed using the foundation design template provided. The backwall height is limited to a range of 6 to 12 ft, and the soil type is classified as cohesive or cohesionless. The design methodology was developed using the guidelines specified by the American Association of State Highway Transportation Officials Standard Specifications, the Iowa Department of Transportation Bridge Design Manual, and the National Design Specifications for Wood Construction.

The second volume introduces and outlines the use of the various design aids developed for this project. Charts for determining dead and live gravity loads based on the roadway width, span length, and superstructure type are provided. A foundation design template was developed in which the engineer can check a substructure design by inputting basic bridge site information. Tables published by the Iowa Department of Transportation that provide values for estimating pile friction and end bearing for different combinations of soils and pile types are also included. Generic standard abutment plans were developed for which the engineer can provide necessary bridge site information in the spaces provided. These tools enable engineers to design and detail county bridge substructures more efficiently.

The third volume provides two sets of calculations that demonstrate the application of the substructure design methodology developed in this project. These calculations also verify the accuracy of the foundation design template. The printouts from the foundation design template are provided at the end of each example. Also several tables provide various foundation details for a pre-cast double tee superstructure with different combinations of soil type, backwall height, and pile type.

TABLE OF CONTENTS

LIST OF FIGURES	vii
LIST OF TABLES	ix
1. INTRODUCTION	1
1.1. Background.....	1
1.2. Objective and Scope	3
1.3. Report Summary.....	4
2. INPUT FROM IOWA ENGINEERS	5
2.1. TR-486 Survey.....	5
2.1.1.Objective and Scope of Survey.....	5
2.1.2.Survey Results and Summary.....	6
2.2. Project Advisory Committee (PAC).....	7
3. LITERATURE REVIEW	9
3.1. Abutment Classifications.....	9
3.2. Available Abutment Design Information.....	12
3.3. Lateral Load Analysis Techniques.....	13
3.3.1.Non-Linear Analysis.....	13
3.3.2.Linear Analysis.....	14
3.3.3.Lateral Load Analysis Comparison.....	18
4. DESIGN METHODOLOGY	25
4.1. Design Loads.....	25
4.1.1.Gravity Loads.....	25
4.1.1.1. Dead Load.....	25
4.1.1.2. Live Load.....	29
4.1.2.Lateral Loads.....	30
4.2. Structural Analysis.....	31
4.2.1.Internal Pile Forces.....	31
4.2.1.1. Axial Pile Force.....	31
4.2.1.2. Pile Bending Moment and Anchor Rod Force.....	32
4.2.2.Internal Anchor Block Forces.....	34
4.2.3.Miscellaneous Element Forces.....	34

4.3. Capacity of Foundation Elements.....	35
4.3.1.Pile Capacity.....	35
4.3.1.1. Bearing Capacity.....	35
4.3.1.2. Structural Capacity.....	36
4.3.1.2.1. Steel Piles.....	36
4.3.1.2.2. Timber Piles.....	39
4.3.2.Anchor Block Capacity.....	43
4.3.2.1. Lateral Capacity.....	43
4.3.2.2. Structural Capacity.....	46
4.3.3.Miscellaneous Substructure Elements.....	46
4.4. Design Checks of Foundation Elements.....	46
5. ALTERNATIVE LOW-VOLUME ABUTMENT SYSTEMS.....	49
5.1. Micropiles.....	49
5.2. Geosynthetic Reinforced Soil Bridge Abutments.....	51
5.3. Geopier Foundations.....	55
5.4. Sheet Pile Abutments.....	58
6. REPORT SUMMARY.....	63
7. RECOMMENDED RESEARCH.....	67
8. ACKNOWLEDGEMENTS.....	69
9. REFERENCES.....	71
APPENDIX A. TR-486 SURVEY.....	75
APPENDIX B. TR-486 SURVEY SUMMARY.....	81

LIST OF FIGURES

Figure 1.1.	Cross-section of the original beam-in-slab system [adapted from Klaiber et al., 2004].....	2
Figure 1.2.	Cross section of a modified beam-in-slab system [adapted from Klaiber et al., 2004].....	2
Figure 1.3.	Cross-section of the Winnebago County Bridge [adapted from Wipf et al., 2003].....	3
Figure 1.4.	Cross-section of the Buchanan County Bridge [adapted from Wipf et al., 2003].....	3
Figure 3.1.	Typical Iowa county stub abutment using a steel channel pile cap.....	10
Figure 3.2.	Typical Iowa county stub abutment using a cast-in place reinforced concrete pile cap.....	10
Figure 3.3.	Example of a stub abutment system commonly used by many state DOT's [adapted from Iowa DOT standards designs].....	11
Figure 3.4.	Stub abutment system with a precast concrete panel backwall [photo courtesy of Black Hawk County, Iowa].....	12
Figure 3.5.	Pile model with non-linear springs [adapted from Bowles, 1996].....	14
Figure 3.6.	Example of a typical stiffness-deflection (p-y) curve.....	15
Figure 3.7.	Behavior of a laterally loaded pile in a cohesive soil [adapted from Broms, March 1964].....	16
Figure 3.8.	Behavior of a laterally loaded pile in a cohesionless soil [adapted from Broms, May 1964].....	17
Figure 3.9.	Resolving a lateral pile loading to an equivalent pile head point load and moment.....	19
Figure 3.10.	Maximum pile moment vs. backwall height for piles spaced on 2 ft – 8 in. centers in stiff cohesive soil (SPT blow count of N = 25).....	22
Figure 3.11.	Maximum pile moment vs. backwall height for piles spaced on 2 ft – 8 in. centers in soft cohesive soil (SPT blow count of N = 2).....	22
Figure 3.12.	Maximum pile moment vs. backwall height for piles spaced on 2 ft – 8 in. centers in cohesionless soil (SPT blow count of N = 25).....	23
Figure 4.1.	Graphical representation of the design methodology for a LVR bridge abutment.....	26

Figure 4.2.	Estimated dead load abutment reactions for a 24 ft roadway width.....	27
Figure 4.3.	Estimated dead load abutment reactions for a 30 ft roadway width.....	27
Figure 4.4.	Maximum live load abutment reaction without impact for two, 10 ft design lanes	29
Figure 4.5.	Lateral soil pressure distributions [adapted from the Iowa DOT BDM, 2004].....	30
Figure 4.6.	Location of anchor block for maximum efficiency [adapted from Bowles, 1996].....	44
Figure 4.7.	Soil pressure distribution used to determine the lateral anchor block capacity [adapted from Bowles, 1996].....	45
Figure 5.1.	Micropile construction sequence [adapted from FHWA, 2002].....	51
Figure 5.2.	Cross-section of a GRS bridge abutment [adapted from Abu-Hejleh et al., 2000].....	52
Figure 5.3.	A preloaded and prestressed GRS structure [adapted from Uchimura et al., 1998].....	54
Figure 5.4.	Geopier element construction sequence [adapted from Wissman et al., 2000].....	56
Figure 5.5.	High-energy, low-frequency hammer used for the construction of Geopier foundations [photo courtesy of the Iowa DOT].....	56
Figure 5.6.	Retaining wall with Geopier uplift elements [adapted from White et al., 2001].....	57
Figure 5.7.	Cross-section view of a sheet pile abutment.....	58
Figure 5.8.	Plan view of a combination box and flat sheet pile abutment below the pile cap.....	59
Figure 5.9.	Plan view of an open cell sheet pile abutment [adapted from Nottingham et al., 2000].....	61

LIST OF TABLES

Table 3.1.	Summary of the soil properties used in LPILE.....	20
Table 4.1.	Nominal axial pile factors for various superstructure systems.....	32
Table 4.2.	Effective length factors and pile lengths between braced points.....	39
Table B.1.	Summary of survey TR-486.....	83

1. INTRODUCTION

1.1. BACKGROUND

In the 1994 Iowa Highway Research Board (Iowa HRB) Project HR-365, several replacement bridges being used by Iowa counties and the surrounding states were identified, reviewed and evaluated [1]. Results of a survey of the Iowa County Engineers and neighboring states indicates that:

- Sixty-nine percent of the Iowa counties have the capabilities to construct relatively short spans bridges with their own forces.
- The most commonly used replacement bridges are continuous concrete slabs and prestressed concrete girder bridges for the primary reason that standard designs are readily available and have minimal maintenance requirements.
- There are several unique replacement bridge systems that are constructed by county forces.
- Two bridges systems were identified for additional investigation.

The development of the first system, Steel Beam Precast Units, started in the Iowa HRB Project HR-382 [2, 3]. The Steel Beam Precast Unit concept involves the fabrication of a precast unit constructed by county forces. The precast units are composed of two steel beams connected by a composite concrete slab. The deck thickness in the precast units are limited to reduce unit weight so that the units can be fabricated off site and then transported to the bridge site. Once at the bridge site, adjacent precast units are connected and the remaining overlay portion of the concrete deck is placed. A Steel Beam Precast Unit demonstration bridge was constructed and tested along with the development of design software, a set of designs for a range of roadway widths and span lengths, and generic plans.

The development of the second bridge system which involves the modification of the Benton County Beam-in-Slab Bridge (BISB), TR-467 [4], is currently in progress. The cross-section of the original BISB system and the modified BISB system are shown in Figures 1.1 and 1.2, respectively. The basic differences in the two systems are the removal of the structurally ineffective concrete from the tension side of the cross-section and the addition of an alternate shear connector. The alternate shear connector was developed as a part of HR-382 to create composite action between the steel beams and the concrete. These two modifications decrease the superstructure dead load and improve the structural efficiency thus allowing the modified BISB to span greater lengths. Upon the

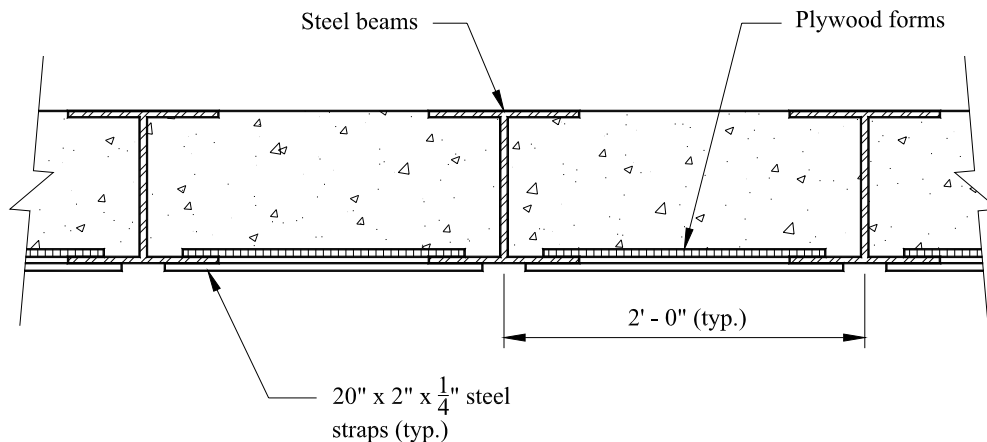

Figure 1.1. Cross-section of the original beam-in-slab system [adapted from Klaiber et al., 2004].

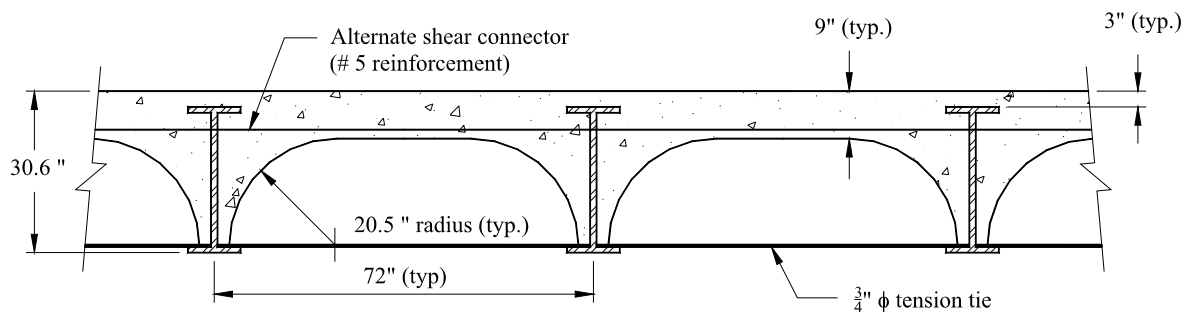

Figure 1.2. Cross section of a modified beam-in-slab system [adapted from Klaiber et al., 2004].

completion of TR-467, a design methodology will be developed along with a generic set of plans for the bridge system.

In Iowa HRB Project TR-444 [5], a railroad flatcar (RRFC) superstructure system for low-volume Iowa county roads was developed. This project involved inspecting various decommissioned RRFC's for use in demonstration bridges, the construction and laboratory testing of a longitudinal joint between adjacent RRFC's, the design and construction of two RRFC demonstration bridges, and development of design recommendations for future RRFC bridges. The cross-section of a three-span RRFC bridge (total length = 89 ft) built in Winnebago County, Iowa in 2002 is presented in Figure 1.3, while the cross-section of the single-span RRFC bridge (total length = 56 ft) built in Buchanan County, Iowa in 2002 is presented in Figure 1.4.

As previously noted, various superstructure design methodologies have been developed by the Iowa State University (ISU) Bridge Engineering Center (BEC), however to date no standard abutment designs have been developed. Obviously with a set of abutment standards and the various superstructures previously developed, a County Engineer could design the complete bridge at a given

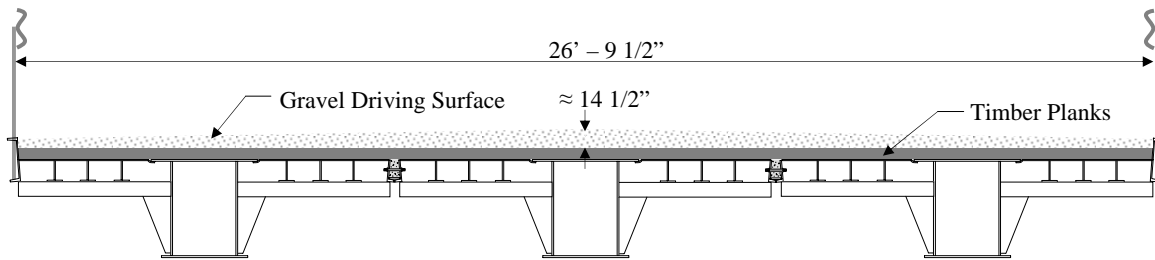

Figure 1.3. Cross-section of the Winnebago County Bridge [adapted from Wipf et al., 2003].

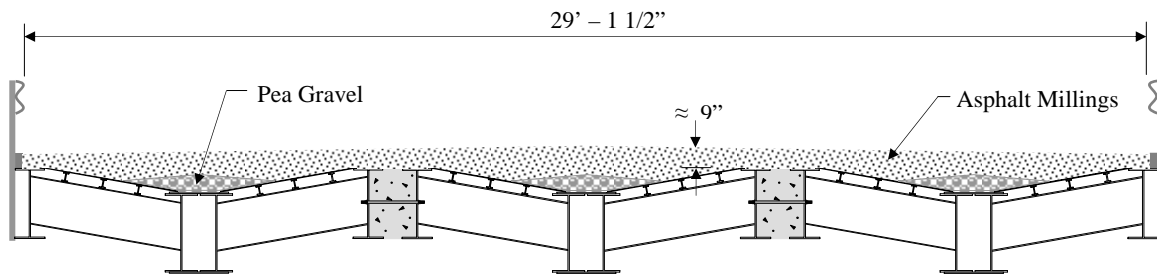

Figure 1.4. Cross-section of the Buchanan County Bridge [adapted from Wipf et al., 2003].

location. Thus, there was need to establish an easy to use design methodology in addition to generating generic abutment standards for the more common substructure systems used in Iowa.

1.2. OBJECTIVE AND SCOPE

The objective of this project was to develop a series of standard abutment designs, a simple design methodology, and a series of design aids for the more commonly used substructure systems. These tools will assist Iowa County Engineers in the design and construction of low-volume road (LVR) bridge abutments. The following tasks were undertaken to meet the research objective.

- Conduct a survey of the Iowa counties to determine current design practices and construction capabilities.
- Investigation of various LVR bridge abutments used by agencies outside of Iowa.
- Identify practical abutments for additional review.
- Develop a simple design methodology and series of standard abutment plans for the selected abutment systems.
- Create a series of standard abutment design aids.

Details on how these research objectives were achieved are presented in the following sections.

1.3. REPORT SUMMARY

This report is divided into three volumes. Volume 1 includes the survey results of the Iowa County Engineers, the development of the abutment design methodology, standard designs, design aids, and a summary of additional research required. Many different sources of information were utilized in the development of the standard abutment plans and design aids. This includes technical articles, the websites of several state departments of transportation (DOT's), plus the input of local Iowa County Engineers. This input from the local Iowa Engineers was obtained from a survey distributed by the BEC to the Iowa County Engineers and from members of the Project Advisory Committee (PAC). The members of the PAC represented Iowa counties as well as the Iowa Department of Transportation (Iowa DOT).

Volume 1: *Development of Design Methodology* also includes the design methodology developed for this project. This includes the determination of gravity and lateral loads, performing the structural analysis, computing the system capacity, and performing various design requirement checks. A summary of research needed on alternative abutment systems (which are easy to construct, applicable in a wide range of situations, and are cost competitive) is also presented.

Volume 2: *Users Manual* provides a set of LVR bridge abutment design aids and instructions on how to use them. All of the design aids and design equations are included in the appendices of Volume 2. This includes: estimated gravity loads, driven pile foundation soils information chart, printouts from the foundation design template, generic standard abutment plans, and design methodology equations with selected figures.

In Volume 2, three figures are provided to determine conservative dead and live load abutment reactions for various span lengths of some LVR bridge systems. A description of all input values required for using the foundation design template (FDT) along with recommendations for the optimization of a foundation design are presented. The instructions for using the standard abutment plans are also provided. By modifying the abutment bearing surface, this methodology can be used to design the foundation system for essentially any type of bridge superstructure system.

Volume 3: *Verification of Design Methodology* provides two sets of calculations that demonstrate the application of the substructure design methodology developed in this project. These calculations also verify the accuracy of the FDT. The printouts from the FDT are provided at the end of each example. Additionally, several tables present various foundation details for a pre-cast double tee superstructure (PCDT) with different combinations of soil type, backwall height, and pile type.

2. INPUT FROM IOWA ENGINEERS

The objective of this project was to create an easy-to-use design methodology and design aids to assist Iowa County Engineers in the development, design, and construction of various types of LVR bridge abutments. To accomplish this objective, local Iowa Engineers needed to be actively involved in the project, providing information, guidelines and recommendations to the research team. This included providing information on the design of the most common abutment systems, construction practices, and the county capabilities in these respective areas. This information was collected through a survey sent to the Iowa counties and from the PAC recommendations.

2.1. TR-486 SURVEY

Prior to this project, the design methodologies and construction practices of the Iowa counties were not entirely known. This included the details and types of bridge site investigations conducted prior to the design, what percentage of counties design and construct their own abutments, what percentage hire a consultant or contractor for the substructure design and/or construction, the equipment and labor requirements for the construction of the most common abutment types, and the common foundation element trends or patterns for various geographic locations throughout the state.

2.1.1. Objective and Scope of Survey

The objective of this survey was to obtain information relating to the common abutment designs and construction practices of Iowa counties. This information was collected to help guide other aspects of this project. One area of primary interest was the type and level of design work performed by the Iowa County Engineers for LVR bridge abutments. Specifically, it was desired to know if county engineering departments perform a majority of the design work in-house, or if private consultants are hired. Information relating to design methodologies and standard abutment designs that are commonly used as well as their limitations and applicability was also desired.

Another area of interest was related to the bridge foundation. This includes information on the type, quantity and typical depths of bridge foundation elements (e.g., steel and timber piles). Similarly, information regarding the common types of subsurface explorations was needed to fully understand typical county designs.

It was also desired to determine methods used by counties in the construction of LVR bridge abutments. It was unknown if counties use county personnel for the construction of a typical LVR bridge or if private contractors are employed. Additionally, the type of equipment and the amount of labor required for the construction of a typical LVR bridge abutment was not known.

In an attempt to answer these questions, TR-486 survey (included in Appendix A) was developed and sent to Iowa County Engineers in the summer of 2003.

2.1.2. Survey Results and Summary

A detailed summary of the results of the survey is presented in Appendix B. The results in Appendix B are grouped according to the six Iowa DOT transportation districts. A brief summary of the complete survey results is presented below:

- Forty-six percent of counties (46 of 99 counties) completed and returned the survey.
- Seventeen percent of the responses (eight counties) stated that they use some type of standard abutment design; six counties sent drawings or plans.
- For the standard abutment designs that are used by Iowa counties, the following general limitations apply: single span lengths ranging from 20 to 90 ft, small or no skew angles, situations when shallow bedrock is typically not encountered, and de-icing salts are generally not used.
- Twenty-six percent of the responses (12 counties) stated that they knew of other agencies with standard abutment plans. The other agencies listed include: other counties, Oden Enterprises, and the Iowa DOT. It should be noted that some counties that were mentioned stated that they did not use standard abutment plans.
- The equipment required for the construction of a typical LVR bridge abutment varied by county. Among the more common pieces of equipment mentioned were: cranes, vibrating and hammer pile drivers, excavators, and welders.
- The labor force required for construction of a standard abutment, when given in terms of man-hours, varied from 72 to 400 hours depending on the county. Some labor requirements were stated as: “four laborers” or “three to four workers, three to six weeks”.
- Twenty-eight percent of the responses (13 counties) have their own bridge construction crew, 63 percent of the responses (29 counties) hire a contractor and nine percent (4 counties) use both alternatives.
- Fifty-six percent of the responses (26 counties) stated that some type of site investigation is performed before the installation of bridge foundation elements.
- Forty-five percent of the responses (21 counties) specifically stated that some type of subsurface exploration is performed and 13 percent (six counties) specifically cite that a SPT test is performed. No other specific soil test was mentioned.

- Sixty-five percent of the responses (30 counties) stated that steel H-piles are used at least some of the time, whereas 33 percent of the responses (15 counties) use timber piles at least some of the time, and ten percent of the responses (5 counties) indicate use of reinforced concrete piles.
- The installation depth for steel H-piles ranged from 20 to 90 ft, depending on the county, with the most common depth being approximately 40 ft. The depth for timber piles ranged from 20 to 40 ft, depending on the county, with the most common depth being approximately 30 ft.

2.2. PROJECT ADVISORY COMMITTEE (PAC)

In addition to the results from the Iowa County Engineer's survey, the previously mentioned PAC was formed to provide additional information and guidance. Members of the PAC consisted of Brian Keierleber (Buchanan County Engineer), Mark Nahra (Delaware County Engineer), Tom Schoellen (Assistant Black Hawk County Engineer,), and Dean Bierwagen (Methods Engineer, Iowa Department of Transportation). The PAC committee was created to provide the research team professional input throughout the various stages of the project.

The PAC provided very valuable information relating to the scope of the project. In meetings with the PAC, it was decided that standard abutment designs should include roadway widths of 24 and 30 ft with single span lengths ranging from 20 to 90 ft. It was also suggested that the standard abutment designs should accommodate different superstructure types such as the RRFC, BISB, PCDT, prestressed concrete girders (PSC), quad tee's, glued-laminated (glulam) timber girders, and slab bridges. Additionally, since 6 to 12 ft is a common range for the abutment backwall heights in Iowa, it was decided to limit the designs to this range. The PAC noted that most Iowa counties primarily use steel and timber piles, and thus should be the two materials investigated for use in the abutment designs. Finally, members of the PAC stated that some type of computer based design aid would be very useful in assisting the County Engineers in the design of the foundation elements. This design aid needs to be easy to use and readily available. The operating system suggested by the members of the PAC was visual basic or an Excel spreadsheet.

After the initial scope of the project was defined, members of the PAC were frequently contacted about issues relating the design methodology and design aids. Issues such as the use of anchor systems, tiebacks, sheet piles, and lateral load analysis were all addressed. Additionally, members of the PAC provided guidance and suggestions on the practicality and format of the design aids being developed so they could be easily used by Iowa County Engineers.

3. LITERATURE REVIEW

A literature search was performed to collect information on standard abutment plans and design methodologies that are currently used for LVR bridge abutments. Several sources including: 1.) all state DOT websites, 2.) the Federal Highway Administration (FHWA), 3.) the Local Technology Assistance Program (LTAP) network, and 4.) the Transportation Research Information Services (TRIS) were used in the literature search.

The literature reviewed in this report is not intended to be all inclusive on the topic of LVR bridge abutments. It focuses primarily on the information required to develop the design methodology and standard abutment plans for this project. Some additional information such as available standard abutment designs and alternative abutment systems are also included in this review.

3.1. ABUTMENT CLASSIFICATIONS

Abutments systems are generally classified as either integral or stub abutments. In an integral abutment, the superstructure is structurally connected to the substructure with a reinforced concrete end diaphragm, shear key, and/or reinforcing dowel rods. The structural connection subjects the piles to bending loads caused by thermally induced horizontal movements as well as the end rotation of the superstructure from live loads [6]. After a review of project survey results and the input of the PAC presented in Chapter 2, it was evident that integral abutments systems used in Iowa counties are based on the standard designs available through the Iowa DOT [7]. Thus, it was decided that there is already sufficient information available on integral abutments.

The structural connection to the superstructure associated with integral abutments is not used in a typical stub abutment system which is considered a simple support. A typical Iowa county stub abutment consists of a single, vertical row of either steel or timber piles. The pile cap typically consists of either steel channels connected to the pile heads (Figure 3.1) or a cast-in-place reinforced concrete cap (Figure 3.2). A backwall composed of either stacked horizontal timber planks or vertically driven sheet piles are placed behind the exposed piles to form a retaining wall for the backfill soil. The total height of the backwall typically ranges from 6 to 12 ft, which includes the exposed pile length plus the combined depth of the roadway and superstructure. Some counties also use an anchor system to resist the horizontal substructure loadings. This system typically consists of a buried reinforced concrete anchor block (shown in Figures 3.1 and 3.2) that is connected to the abutment system with anchor rods and an abutment wale.

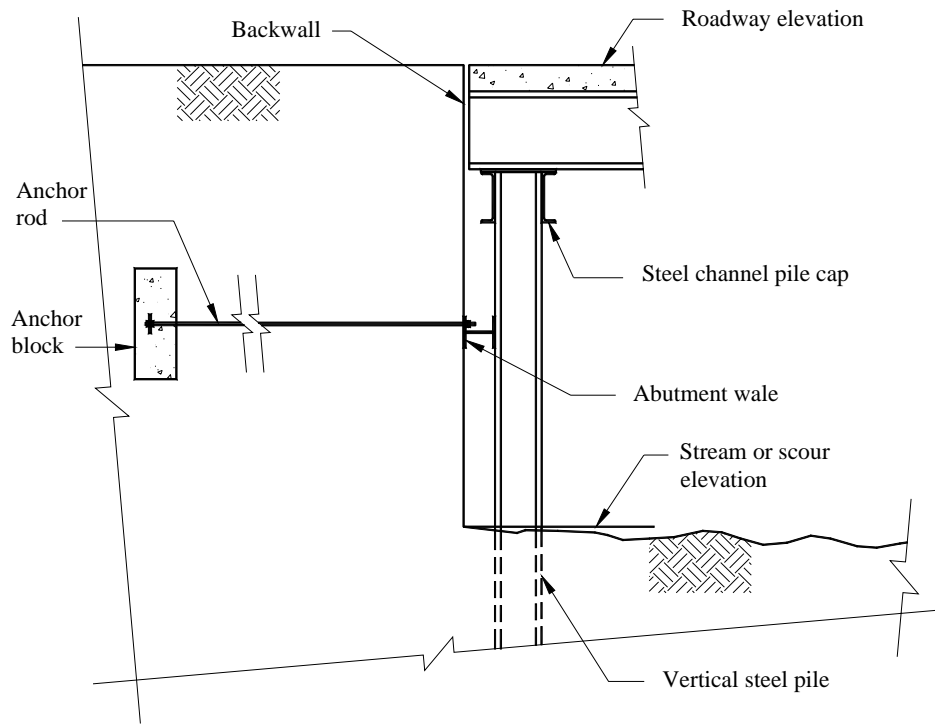

Figure 3.1. Typical Iowa county stub abutment using a steel channel pile cap.

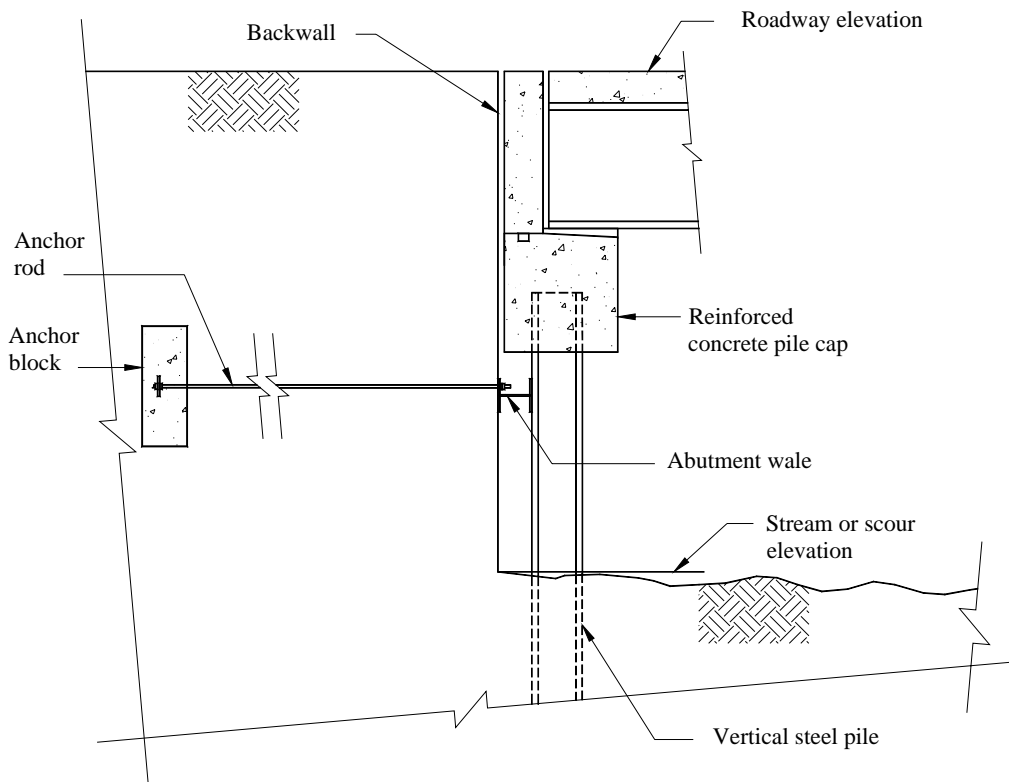

Figure 3.2. Typical Iowa county stub abutment using a cast-in place reinforced concrete pile cap.

Another stub abutment system used by several state DOT's is shown in Figure 3.3. This particular system has two rows of completely embedded steel piles with a cast-in-place reinforced concrete pile cap and backwall. The back row piles (i.e., farthest away from the stream) are vertical whereas the front row piles (i.e., nearest to the stream) are typically battered at a one horizontal to four vertical orientation [8, 9]. The battered piles contribute to the vertical bearing capacity in addition to resisting horizontal loads [10].

The literature search also revealed several additional economical systems that potentially can be used for LVR bridge abutments. This includes micropiles, geosynthetic reinforced soil structures, Geopier foundations, and sheet pile bridge abutments. These systems are well established in various geographic regions or for a specific use, however none of them have been used as a bridge abutment system in Iowa. For this reason, these systems were not included with the standard abutment designs presented herein. However, a more detailed description of these systems is presented later in Chapter 5. In the future, these systems could be introduced into the Iowa transportation system on a trial basis (i.e., demonstration projects) and their performance evaluated.

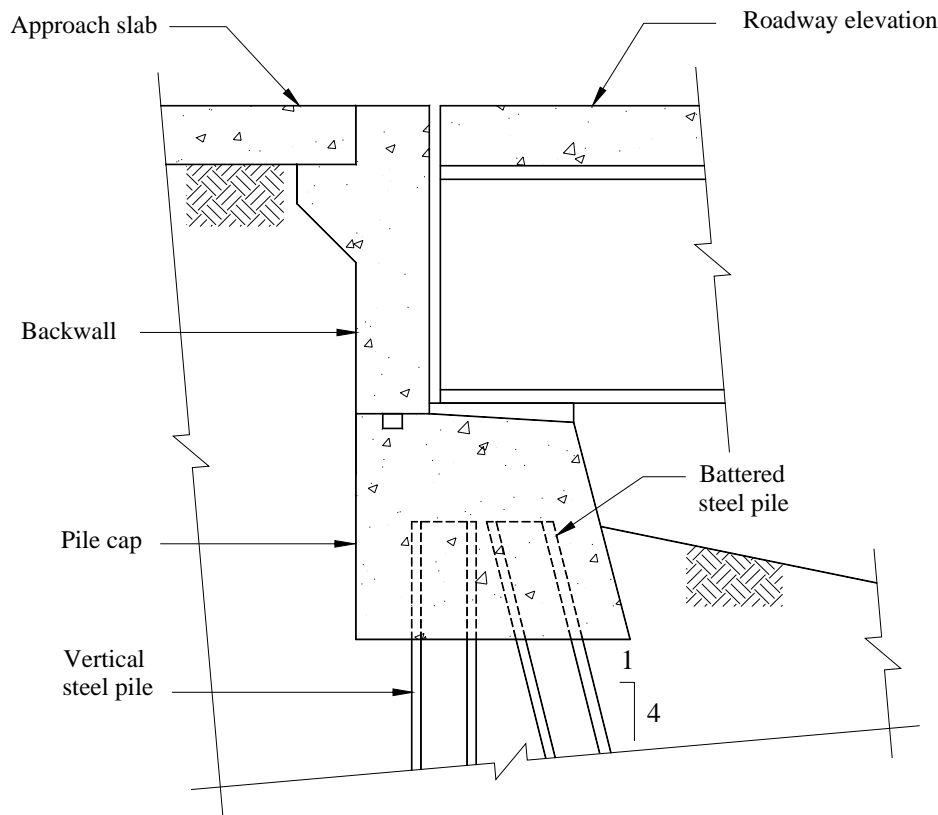

Figure 3.3. Example of a stub abutment system commonly used by many state DOT's [adapted from Iowa DOT standards designs].

3.2. AVAILABLE ABUTMENT DESIGN INFORMATION

An item of particular interest in this literature review was standard abutment plans and designs. The Iowa DOT has developed a series of bridge standards for Iowa county roads [7]. These include standards for prestressed girder and slab bridges with either integral or stub abutments. For example, the Iowa DOT H24S-87 and H30S-87 standards provide complete superstructure and substructure details for a single span, prestressed concrete girder bridge with a roadway width of 24 and 30 ft and span lengths ranging from 30 to 80 ft. The substructure details are similar to those shown in Figure 3.2, which includes a single row of exposed timber piles, a timber plank backwall, and a cast-in-place reinforced concrete pile cap. However the bridge superstructure is integral with the pile cap and backwall system unlike Figure 3.2. Other Iowa DOT standard bridge designs include H24-87, H30-94, J24-87, and J30-87. These standards provide design details for three-span prestressed girder and slab bridges with roadway widths of either 24 or 30 ft. The total bridge lengths range from 126 to 243 ft and 75 to 125 ft for the prestressed concrete girder and slab bridges standards, respectively. The substructure details consist of an integral abutment with a single row of vertical piles.

A review of all 50 state DOT websites revealed a number of different abutment standards available online. Most standards utilize fully embedded piles with either a cast-in-place or pre-cast reinforced concrete pile cap and backwall system. However, the Alabama DOT website [11] provides the details for an abutment system similar to the Black Hawk County, Iowa stub abutment system shown in Figure 3.4. In this system, precast concrete panels are placed between adjacent piles to form the backwall.



Figure 3.4. Stub abutment system with a precast concrete panel backwall [photo courtesy of Black Hawk County, Iowa].

Various state DOT websites, including Iowa [8], New York [12], Ohio [13], Oklahoma [14], Pennsylvania [9], and Texas [15] also provide abutment standards on-line. Additionally, Pennsylvania and Oklahoma provide standard abutment designs specifically for LVR bridge abutments. The Pennsylvania DOT standard design sheets are in a generic format in which the engineer can calculate and then fill-in the necessary information (e.g. roadway width, etc.). The Oklahoma DOT LVR bridge abutment standards sheets are not generic, however standard sheets are available for different superstructure types, span lengths and skew angles.

The National Cooperative Highway Research Program (NCHRP) Synthesis 32-08: *Cost Effective Structures for Off-system Bridges* [16] provides a comprehensive summary of different organizations and government agencies with published bridge standard designs. For example, in the late 1970's and 1980's, the FHWA published bridge standards for concrete, steel and timber superstructures. Unfortunately, these bridge standards have not been updated to include code changes. Other organizations such as the American Iron and Steel Institute, the Concrete Reinforcing Steel Institute, the U.S. Army Corps of Engineers, the U.S. Navy Facilities Command, and the Precast/Prestressed Concrete Institute have also published bridge standards that include substructure details.

3.3. LATERAL LOAD ANALYSIS TECHNIQUES

The foundation elements most commonly used for LVR bridge abutments in Iowa consist of the vertical steel or timber piles previously described. Two different methods for determining the pile behavior when subjected to lateral loads were reviewed for this project.

3.3.1. Non-Linear Analysis

The first lateral load analysis method is commonly known as the p-y method. This analysis technique utilizes a series of non-linear, horizontal springs to represent the soil reaction imparted on the pile when subjected to lateral loads. The pile is modeled as a string of elements with horizontal springs attached to the nodes as shown in Figure 3.5. The springs have stiffness properties selected to simulate the surrounding soil. Each spring imparts a horizontal force on the pile that can be defined by the non-linear relationship of Equation 3.1 [10].

$$F = p y \tag{3.1}$$

where:

F = Spring force representing the soil reaction at the node location.

p = Non-linear soil stiffness that is a function of the lateral displacement.

y = Lateral displacement.

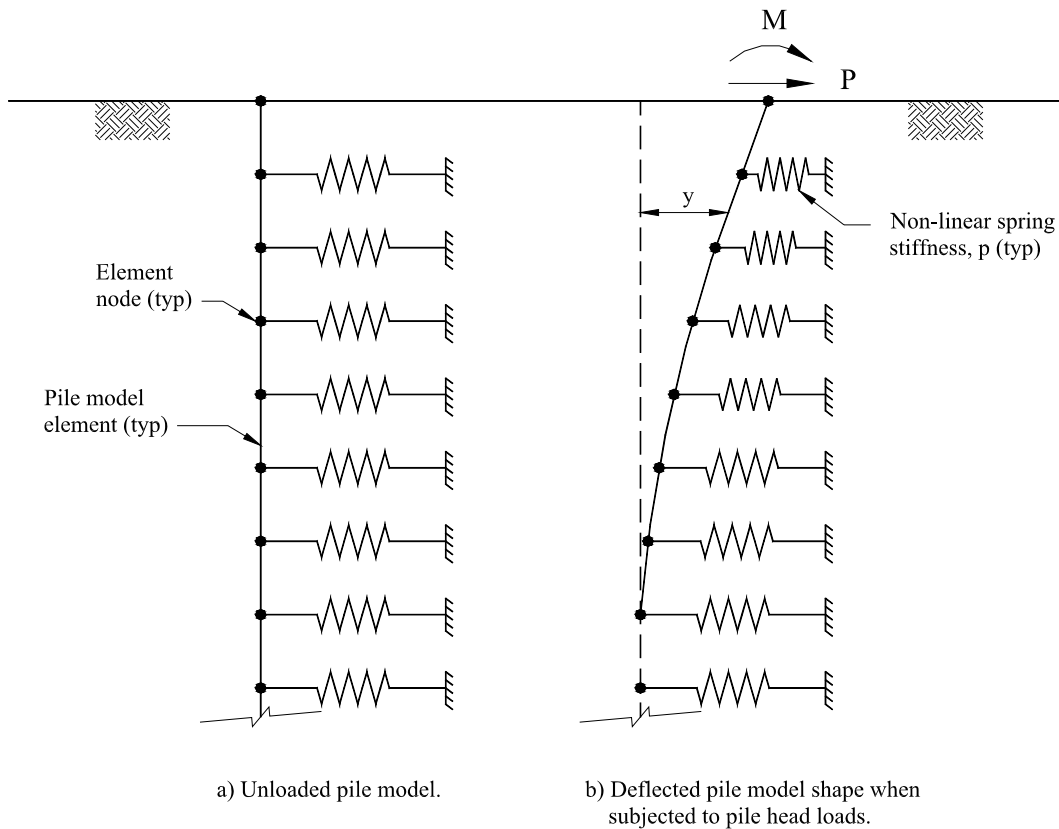

Figure 3.5. Pile model with non-linear springs [adapted from Bowles, 1996].

The magnitude of the applied soil stress has a significant influence on the soil stiffness. As the depth below the ground surface increases, the associated increase in vertical stress will induce an associated increase in the soil stiffness. Additionally, the lateral pile movement will also convey additional stresses on the soil. Because of the dependence on depth, different non-linear spring stiffness values are assigned to each spring in the pile model thus creating a statically indeterminate, non-linear system. Typically, empirical equations developed from lateral load tests are used to model the stiffness-deflection relationship of a particular soil [10]. A typical stiffness-deflection relationship is shown in Figure 3.6.

3.3.2. Linear Analysis

The second lateral load analysis method was developed by Broms [17, 18]. This method considers a sufficiently long pile, fixed at a calculated depth below ground. By assuming a point of fixity, the pile can be analyzed as a cantilever structure with appropriate boundary conditions and external loadings. The calculated depth to fixity is a function of the soil properties, pile width, lateral loadings and pile head boundary conditions. The pile moment and deflection can be determined using structural analysis techniques. The depth to fixity for a pile in a cohesive soil is presented

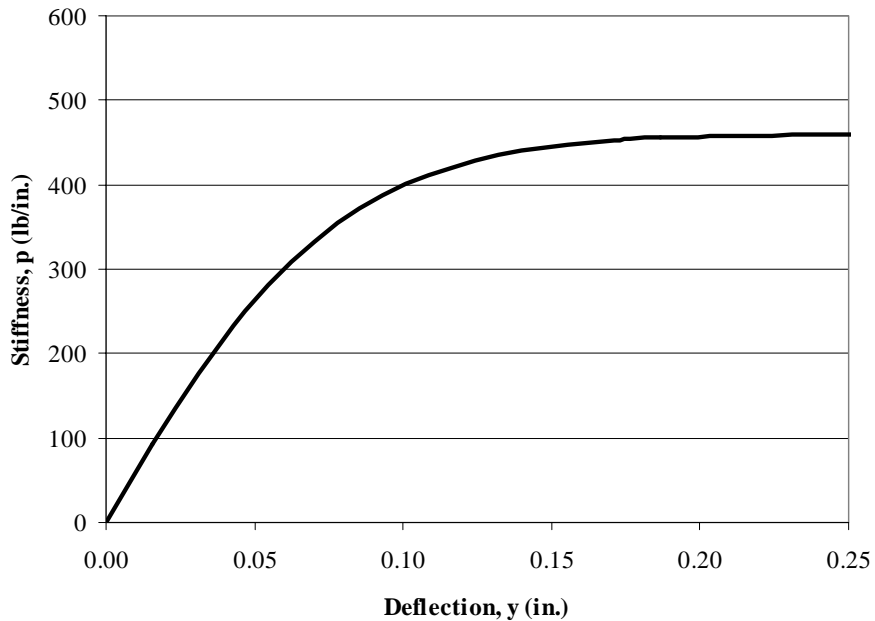

Figure 3.6. Example of a typical stiffness-deflection (p-y) curve.

in Equation 3.2. The general deflected shape, passive soil reaction, and moment diagram for a pile in a cohesive soil is shown in Figure 3.7.

$$L = 1.5B + f \quad (3.2)$$

where:

B = Pile width parallel to the plane of bending.

f = Length of pile required to develop the passive soil reaction to oppose the above ground lateral pile loads (determined using Equation 3.3).

L = Depth to fixity below ground level.

The first term in Equation 3.2 represents the distance in which no passive soil reaction acts on the pile as shown in Figure 3.7. The second term represents the length of pile required to develop the passive soil reaction to oppose the above ground lateral pile loads which is determined using Equation 3.3. The length of pile determined using Equation 3.3 is used to obtain the pile moment at the point of fixity (Equation 3.4).

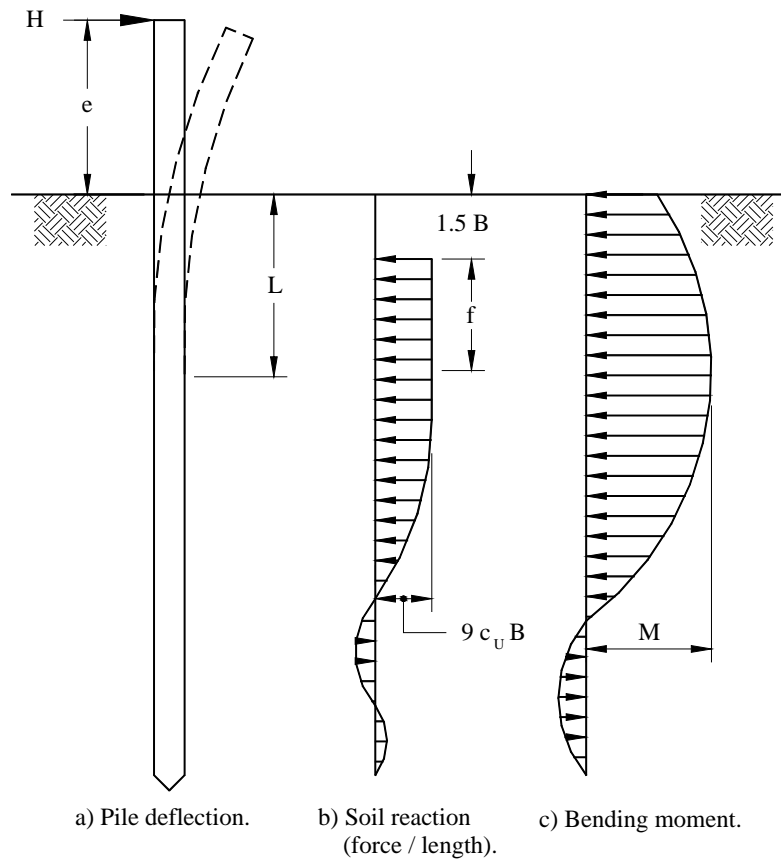

Figure 3.7. Behavior of a laterally loaded pile in a cohesive soil [adapted from Broms, March 1964].

$$f = \frac{H}{9 c_u B} \quad (3.3)$$

where:

B = Pile width parallel to the plane of bending.

c_u = Undrained shear strength of the soil.

f = Length of pile required to develop the passive soil reaction to oppose the above ground lateral pile loads.

H = Total magnitude of the above ground lateral pile loads.

$$M = H(e + 1.5B + 0.5f) \quad (3.4)$$

where:

B = Pile width parallel to the plane of bending.

e = Distance above ground level to the centroid of the lateral pile loads.

f = Length of pile required to develop the passive soil reaction to oppose the above ground lateral pile loads (determined using Equation 3.3).

H = Total magnitude of the above ground lateral pile loads.

M = Moment in pile at the point of fixity.

The general deflected shape, passive soil reaction, and moment diagram for a long pile in a cohesionless soil is shown in Figure 3.8. For cohesionless soils, the soil friction angle is the required soil shear strength parameter. The depth to pile fixity is calculated using Equation 3.5. This equation represents the length of pile required to develop the necessary passive soil reaction to oppose the above ground lateral pile loads. The depth to pile fixity is used to determine the pile moment at the point of pile fixity (Equation 3.6).

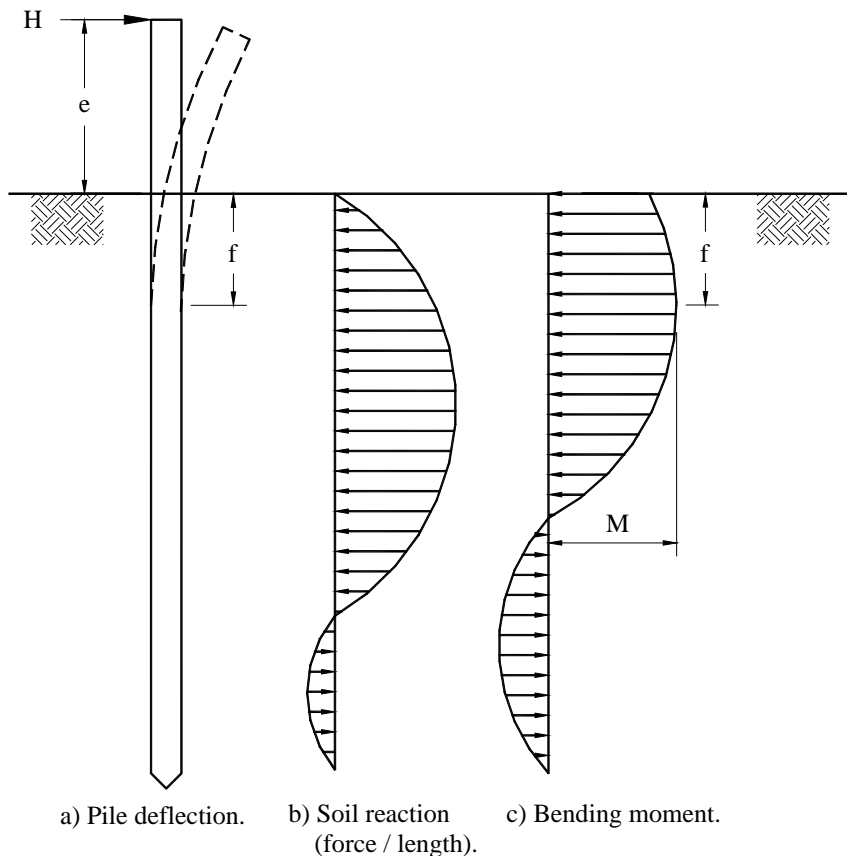

Figure 3.8. Behavior of a laterally loaded pile in a cohesionless soil [adapted from Broms, May 1964].

$$f = 0.82 \sqrt{\frac{H}{\gamma B K_p}} \quad (3.5)$$

where:

B = Pile width parallel to the plane of bending.

f = Depth to fixity below ground level and length of pile required to develop the passive soil reaction to oppose the above ground lateral loads.

H = Total magnitude of the above ground lateral pile loads.

$K_p = \frac{1 + \sin \phi}{1 - \sin \phi}$ = Rankine passive earth pressure coefficient.

γ = Soil unit weight.

ϕ = Soil friction angle.

$$M = H(e + 0.67f) \quad (3.6)$$

where:

e = Distance above ground level to the centroid of the lateral pile loads.

f = Depth to fixity below ground level (determined using Equation 3.5).

H = Total magnitude of the above ground lateral pile loads.

M = Moment in pile at the point of fixity.

3.3.3. Lateral Load Analysis Comparison

The computer software, LPILE Plus v.4.0, which utilizes the non-linear analysis technique was used to determine the maximum pile moment for different soil conditions when the pile is subjected to lateral loads. A significant limitation of LPILE is that all above ground lateral pile loads must be applied at the pile head. Therefore the lateral loadings previously described were resolved to this location as shown in Figure 3.9. An example of the lateral pile loading from the active earth pressure acting on the backwall is shown in Figure 3.9a (discussed later in Chapter 4); the equivalent concentrated load is shown in Figure 3.9b. When the point load is moved to the pile head, a moment needs to be applied as shown in Figure 3.9c to produce the same pile moment at Point A (i.e., at Point A the moments, M_1 and M_2 in Figures 3.9b and 3.9c respectively, are both equal to $P(z - e)$).

Once the equivalent external loads were established, the various soil properties were defined. Initially, eight different homogenous soil conditions were investigated including two cohesive soils with SPT blow counts of 2 and 25 plus six cohesionless soils with blow counts ranging from 6 to 40.

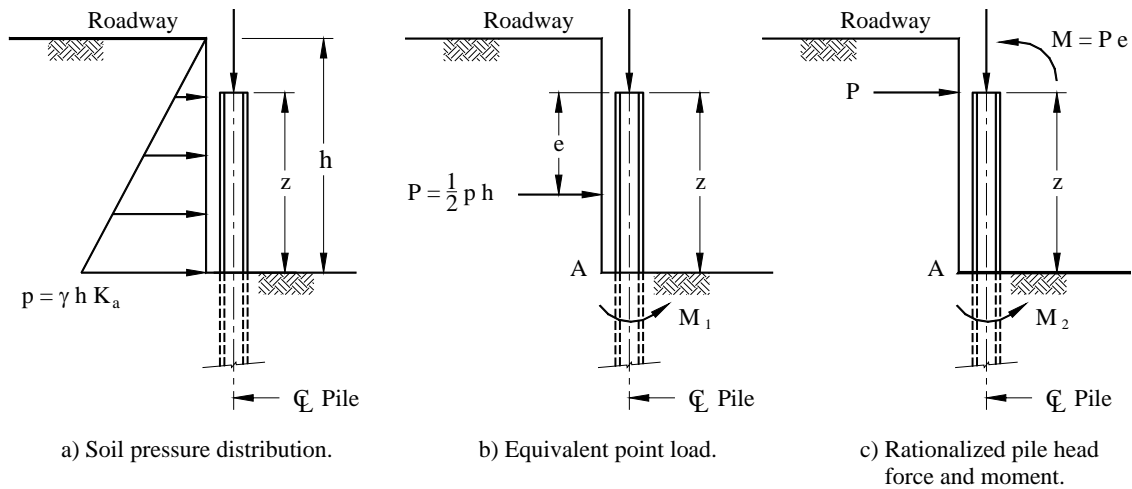

Figure 3.9. Resolving a lateral pile loading to an equivalent pile head point load and moment.

These soils were selected from Table 1.2 in the Iowa DOT Foundation Soils Information Chart (Iowa DOT FSIC) [19] which is presented as Table B.2 in Appendix B of Volume 2. This table, which is described later in Chapter 4, provides estimates of the allowable friction and end bearing values for piles based on the SPT blow count.

The eight soil conditions previously stated can be classified into one of three categories for LPILE analysis: soft cohesive soils or stiff cohesive soils and cohesionless soils. For soft cohesive soils, the undrained shear strength and the soil strain value corresponding to one-half the maximum principal stress difference (ϵ_{50}) are required in addition to the soil unit weight. Terzaghi and Peck [20] present one of the more commonly used correlations (see Equation 3.7) between the SPT blow count and the undrained shear strength. This relationship was selected because the Iowa DOT FSIC [19] also correlates the SPT blow count to soil bearing properties. Since this correlation can be unreliable for some in-situ conditions, it is recommended that, whenever possible, the undrained shear strength be determined by testing soil samples from the bridge site. Estimated ϵ_{50} values used in this study were obtained from the LPILE Technical Manual [21]. A summary of soil parameters used in the LPILE analyses, are provided in Table 3.1.

$$c_u = 0.06 N P_{ATM} \quad (3.7)$$

where:

c_u = Undrained shear strength.

N = SPT blow count.

P_{ATM} = Atmospheric pressure.

Table 3.1. Summary of the soil properties used in LPILE.

SPT Blow Count	Soil Type	c_u	ϕ	ϵ_{50}^*	k^{**}	γ
N	-	(psf)	(degrees)	(in. per in.)	(lb per in ³)	(lb per ft ³)
2	soft cohesive	253	-	0.0201	-	115
6	cohesionless	-	28.6	-	100	115
12	cohesionless	-	30.7	-	150	115
20	cohesionless	-	33.3	-	200	115
40	cohesionless	-	38.5	-	500	115
25	cohesionless	-	34.8	-	250	115
25	stiff cohesive	3,175	-	0.0040	2,000	115
35	cohesionless	-	37.4	-	400	115

* - Obtained from Table 3.2 or 3.4 of the LPILE Technical Manual for soft and stiff cohesive soils, respectively.

** - Obtained from Table 3.3 or Figure 3.29 of the LPILE Technical Manual stiff cohesive soils and cohesionless soils, respectively.

In addition to the undrained shear strength and ϵ_{50} values for stiff cohesive soils, LPILE also requires the modulus of subgrade reaction. The modulus of subgrade reaction is a relationship between the applied soil pressure and corresponding displacement and is commonly used for the structural analysis of foundation elements [10]. The LPILE Technical Manual [21] was used to estimate the modulus of subgrade reaction based on the undrained shear strength of the stiff cohesive soil. As before, Equation 3.7 and the LPILE Technical Manual [21] were both used to determine the undrained shear strength and the value for ϵ_{50} , respectively.

For cohesionless soils, LPILE requires the unit weight of the soil plus the modulus of subgrade reaction (which was estimated from the LPILE Technical Manual [21]) and the soil friction angle. Peck et al. [22] present a correlation (see Equation 3.8) that can be used to obtain the friction angle based on the SPT blow count. Due to uncertainties in empirical relationships, it is recommended that, whenever possible that the soil friction angle be verified from laboratory tests (e.g., direct shear test) on soil samples from the bridge site.

$$\phi = 53.881 - (27.6043 * e^{-0.0147N}) \quad (3.8)$$

where:

N = SPT blow count.

ϕ = Soil friction angle.

The linear analysis technique reported by Broms [17, 18] was also used to determine the maximum moment in laterally loaded piles for different soil conditions. The undrained shear strength and soil friction angle are required for cohesive and cohesionless soils, respectively. The SPT blow count correlations, defined by Equations 3.7 and 3.8, can also be used for this analysis method. As previously noted, the depth to fixity and the corresponding pile moment is determined using Equations 3.2 through 3.6 for the various types of soils.

A comparison of the two lateral load analysis techniques reveals the advantages of both methods. The non-linear method can be used for more complex soil conditions such as a non-homogenous soil profile. It also provides a more accurate representation of the moment distribution along the length of the pile. However, specialized geotechnical software, such as LPILE, is needed to perform this analysis.

Brom's method [17, 18] does not account for the redistribution of pile loads below the point of fixity. Additionally, the soil pressure distributions used to determine the depth to fixity and the shape of the soil reactions were developed in the 1960's and may not be entirely accurate based on the non-linear soil load-deflection response shown in Figure 3.6. However, once the shape of the soil reactions are established, the pile deflection and moment along the length of the pile above the point of fixity can easily be determined. This analysis technique can also be incorporated into commonly available spreadsheet software.

Although the non-linear and linear methods use different assumptions and modeling techniques, they produce comparable maximum pile bending moments for different soil types and lateral loadings. The linear method is somewhat more conservative for stiff cohesive soils when compared to the non-linear method. The relationship between the maximum pile moment and backwall height is shown in Figure 3.10 for piles in stiff cohesive soil (SPT blow count of $N = 25$) spaced on 2 ft – 8 in. centers. Figure 3.10 reveals that as the magnitude of the lateral pile loads decrease (i.e., the backwall height decreases), the maximum pile moments obtained from the linear method are more conservative by 15 percent. As the magnitudes of the lateral loads increase (i.e., the backwall height increases), the maximum pile moments obtained using the linear method are more conservative by approximately seven percent.

In soft cohesive soils, the linear method produces less conservative maximum pile moment values when compared to the non-linear method. The relationship between the maximum pile moment and backwall height is shown in Figure 3.11 for piles in soft cohesive soil (SPT blow count of $N = 2$) also spaced on 2 ft – 8 in. centers. As the magnitude of the lateral loads decreases, the difference between the two analysis methods increases. In this case, the linear method is less

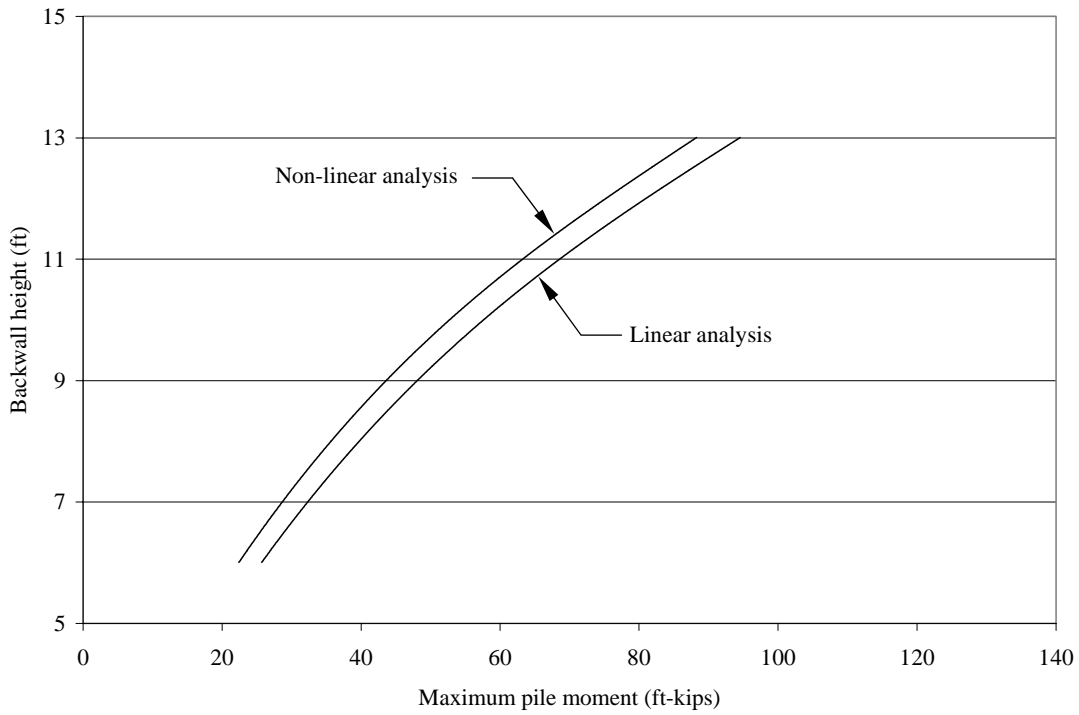

Figure 3.10. Maximum pile moment vs. backwall height for piles spaced on 2 ft – 8 in. centers in stiff cohesive soil (SPT blow count of $N = 25$).

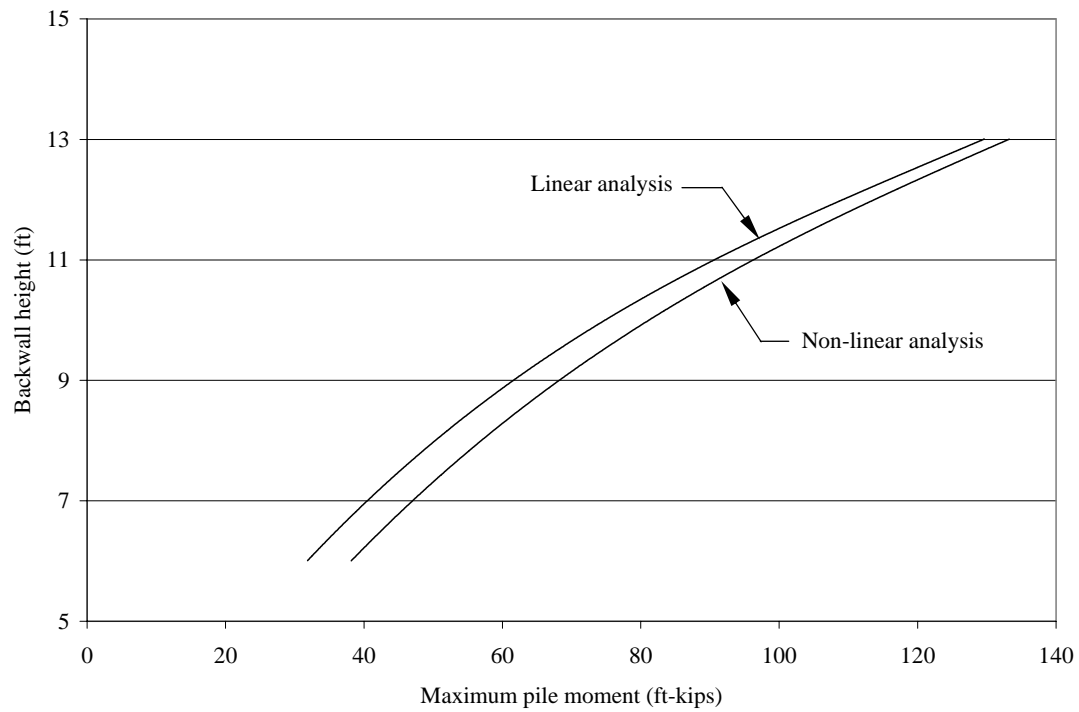

Figure 3.11. Maximum pile moment vs. backwall height for piles spaced on 2 ft – 8 in. centers in soft cohesive soil (SPT blow count of $N = 2$).

conservative by about 20 percent for lower backwall heights. As the magnitude of the lateral loads increases, the two methods converge to within three percent.

Finally, the maximum pile moment values in cohesionless soils obtained from the linear method are slightly more conservative than the non-linear results. The relationship between the maximum pile moment and backwall height is shown in Figure 3.12 for piles in cohesionless soil (SPT blow count of $N = 25$) spaced on 2 ft – 8 in. centers. This conservative difference ranges from zero to three percent and does not vary significantly as the magnitude of the lateral pile loads change.

As previously stated, for certain situations the linear method was less conservative for soft cohesive soils by up to 20 percent. However, given the assumptions used for the development of this design methodology, the general similarity in results when compared to the non-linear method, and the reduced computational requirements, Brom's linear method [17, 18], was selected for use in the LVR bridge abutment design methodology developed in this investigation.

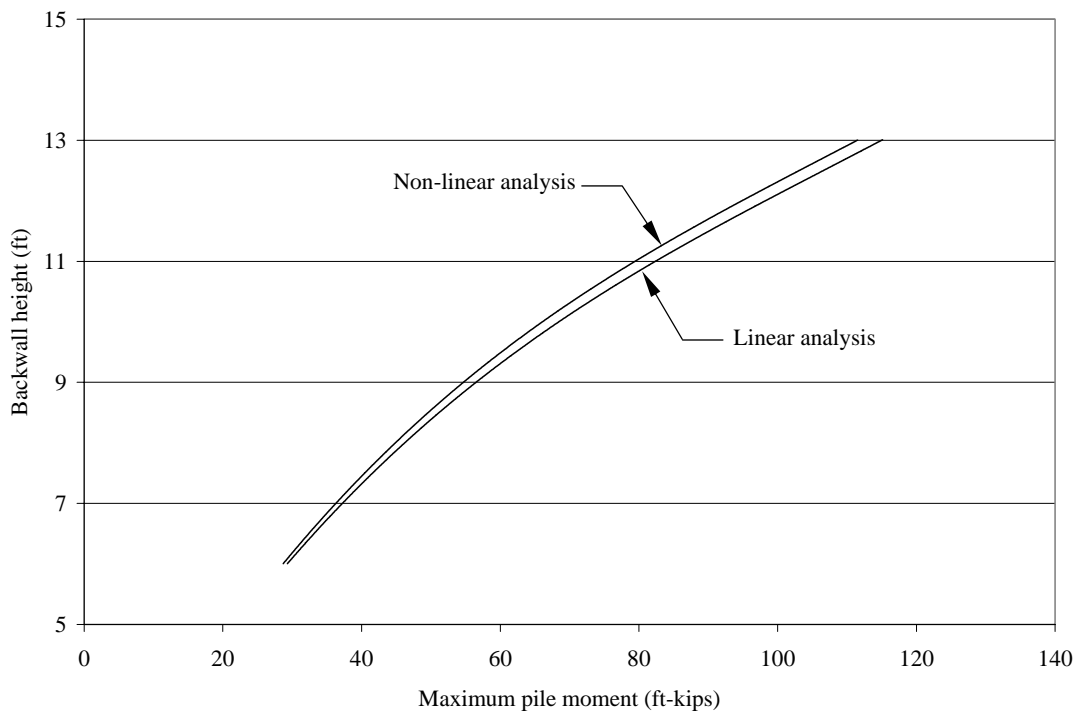

Figure 3.12. Maximum pile moment vs. backwall height for piles spaced on 2 ft – 8 in. centers in cohesionless soil (SPT blow count of $N = 25$).

4. DESIGN METHODOLOGY

In this chapter, a design methodology is developed for the foundation elements most commonly used for LVR bridge abutments in Iowa. This includes determination of substructure loads, structural analyses, determination of the pile and anchor system capacities, and design verification. An overview of additional substructure elements such as pile caps, abutment wales, and backwalls is also presented. A graphical flow chart of the design methodology is shown in Figure 4.1.

4.1. DESIGN LOADS

Once the basic substructure configuration is established (i.e., the number of piles, the lateral restraint system, and the corresponding system properties), the substructure loads must be identified. This step is denoted as Part A in Figure 4.1. Gravity loads include bridge live loads and dead loads due to the superstructure and substructure self-weight. Lateral loadings are imparted to the bridge substructure by active and passive soil pressures in addition to longitudinal braking and lateral wind loads transmitted through the bridge bearings.

4.1.1. Gravity Loads

The identification of substructure gravity loads includes the self-weight of the bridge superstructure and substructure in addition to bridge live loads. The total abutment reaction is obviously equal to the sum of the dead and live load reactions.

4.1.1.1. DEAD LOAD

Conservative total dead load abutment reactions for PCDT, PSC, quad tee, glulam, and slab bridge systems are shown in Figures 4.2 and 4.3 for 24 and 30 ft roadway widths, respectively. It should be noted that the PCDT dead load abutment reactions can also be used for steel girder superstructures. These estimated abutment reactions are based on published standard design sheets for the respective superstructure systems and include the self-weight of both the superstructure and substructure. More accurate and potentially smaller dead load abutment reactions can be calculated by using site-specific bridge information. The dead load abutment reactions for other standard superstructure systems such as the RRFC and BISB systems are not included since there are numerous different cross sections used in these systems which results in different self-weights.

A number of conservative assumptions, applicable to all superstructure systems previously listed, were used to estimate the dead load abutment reactions shown in Figures 4.2 and 4.3. For all superstructure systems, a 20 psf future wearing surface was assumed in addition to two three-beam rails, with a conservatively estimated weight of 50 plf per rail, were assumed for all superstructure

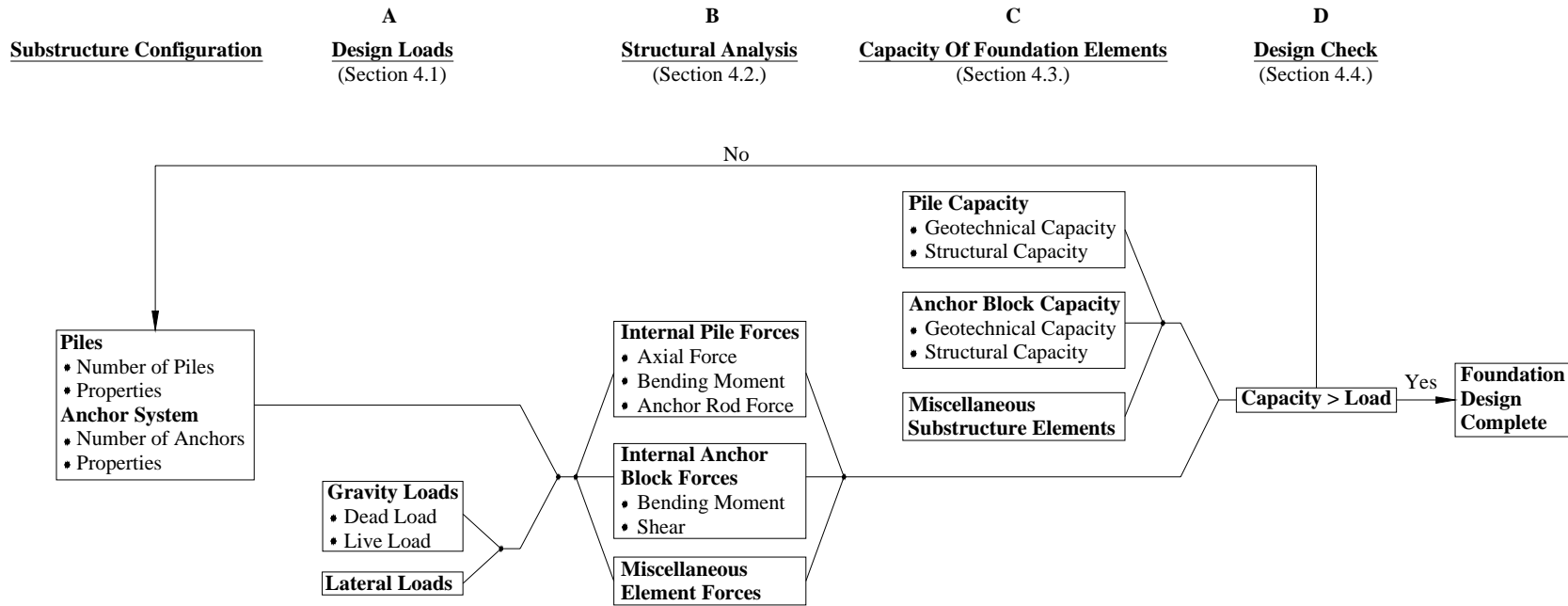

Figure 4.1. Graphical representation of the design methodology for a LVR bridge abutment.

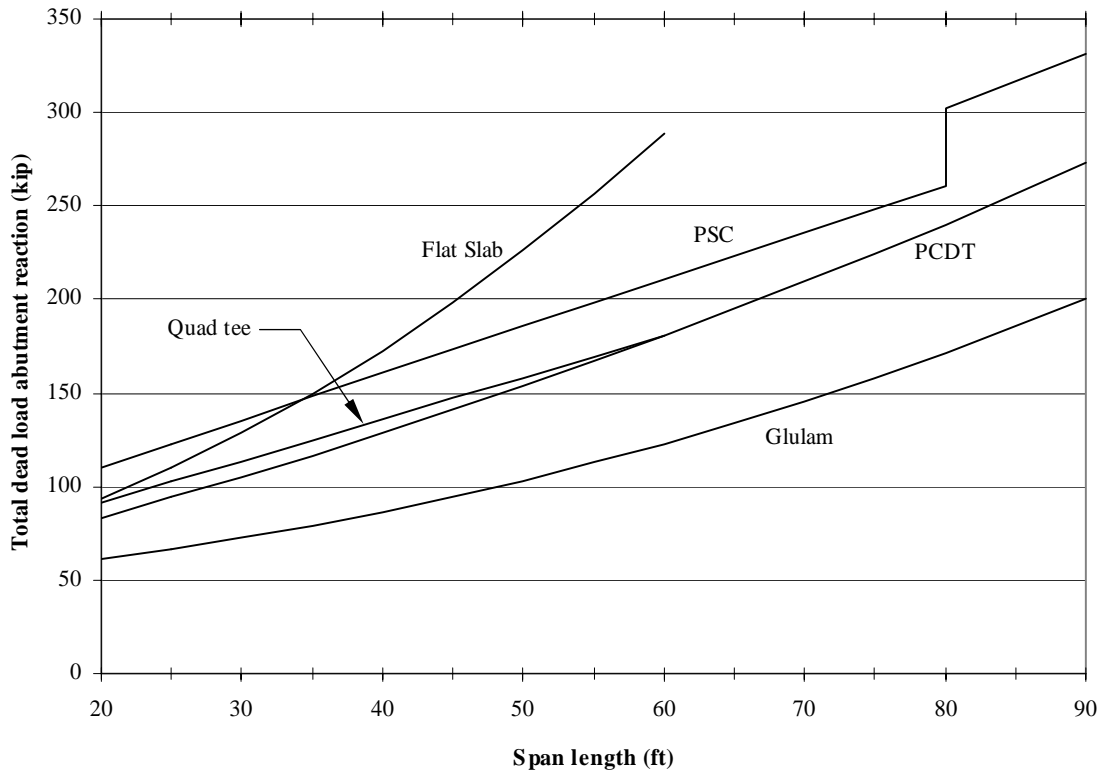

Figure 4.2. Estimated dead load abutment reactions for a 24 ft roadway width.

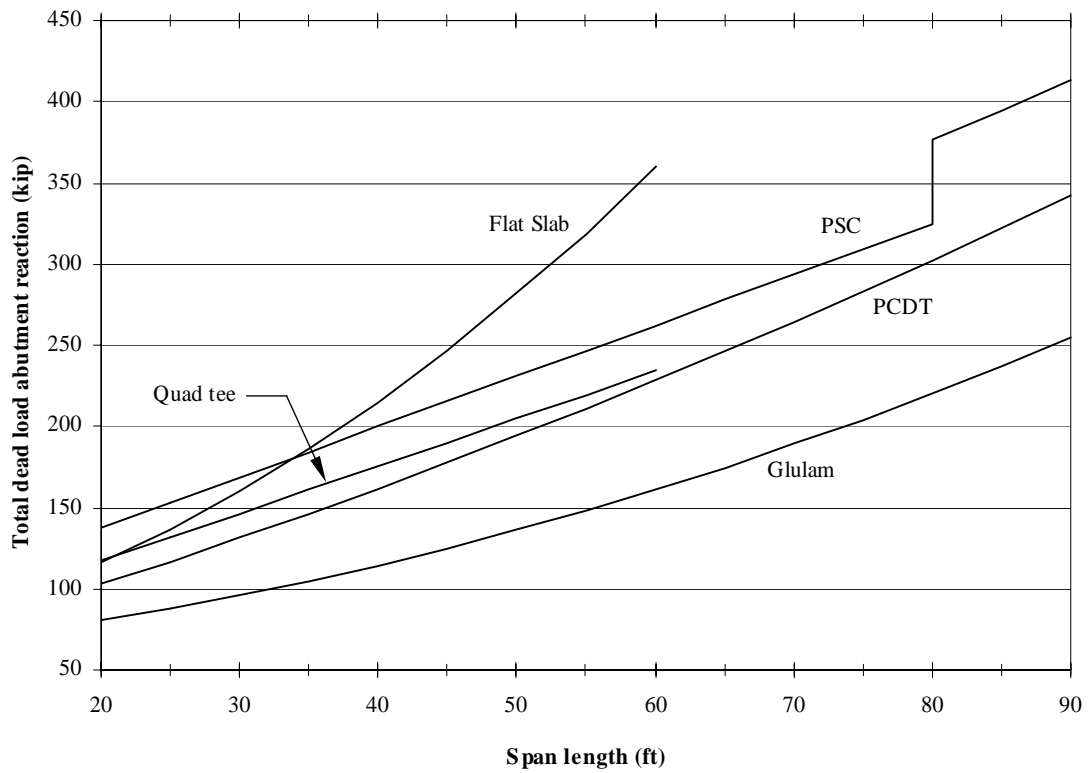

Figure 4.3. Estimated dead load abutment reactions for a 30 ft roadway width.

systems. Many LVR bridge systems use a concrete end diaphragm that acts as soil retaining wall above the pile cap. If the beams are encased in an end diaphragm there will be some end restraint and behavior similar to an integral abutment will occur. This type of connection is not included in this design methodology, however the weight of this wall was included. The estimated substructure dead load includes a three foot by three foot concrete pile cap with a length equal to the roadway width. Additionally, all estimated dead load abutment reactions were increased by five percent because standards for non-specific bridge sites were used.

A list of the assumptions used to estimate the dead load of the superstructure systems shown in Figures 4.2 and 4.3 follows:

Glulam Girders

- United States Department of Agriculture Standard Plans for Timber Bridge Superstructures (2001) [23] were used as a guide for the deck and girder self-weight calculations.
- Since standard design sheets for a 30 ft roadway width were not available, a 32 ft roadway width was used (Figure 4.3).

PSC

- Iowa DOT H24S-87 standard design sheets [7] for a 24 ft, single span PSC system were used as a guide for the slab and girder self-weight calculations.
- Five girders were used for the 30 ft roadway width (Figure 4.3).
- The Iowa DOT LXC standard girder section [7] was used for span lengths ranging from 20 to 80 ft.
- The Iowa DOT LXD standard girder section [24] was used for span lengths ranging from 80 to 90 ft.

PCDT

- PCDT standard design sheets published in Iowa DOT Project TR-410 [25] were used as a guide for the slab and girder self-weight calculations.

Quad Tee

- The Cretex Concrete Products Midwest, Inc. (formerly known as Iowa Concrete Products Company) standard quad tee section [26] was used to estimate the superstructure self-weight.
- Six and eight quad tee sections were used for the 24 and 30 ft roadway widths, respectively.

Slab Bridge

- Iowa DOT J24-87 standard design sheets [7] for a 24 ft, three span slab bridge were used as a guide for superstructure self-weight calculations.
- The center span length to slab depth ratios of the Iowa DOT J24-87 standard design sheets [7] were used to estimate the slab depths for all applicable span lengths.

4.1.1.2. LIVE LOAD

The live load abutment reaction is computed using the HS20-44 design truck from the 1996 American Association of State Highway Transportation Officials Standard Specifications for Highway Bridges, Sixteenth Edition (AASHTO) [27]. Additional live loads such as the AASHTO lane load [27] and Iowa legal loads were also investigated; however, the HS20-44 truck controls for all span lengths defined for the scope of this project (i.e., between 20 and 90 ft). The maximum simple span loading occurs when the back axle is placed directly over the centerline of the piles with the front and middle axles on the bridge. The live load abutment reactions for two, 10 ft wide design traffic lanes without impact are presented in Figure 4.4. These values can be proportioned for a different number of design traffic lanes depending on the roadway width. Additionally, AASHTO [27] defines a lane reduction factor that accounts for the probability of multiple lane loadings. If the

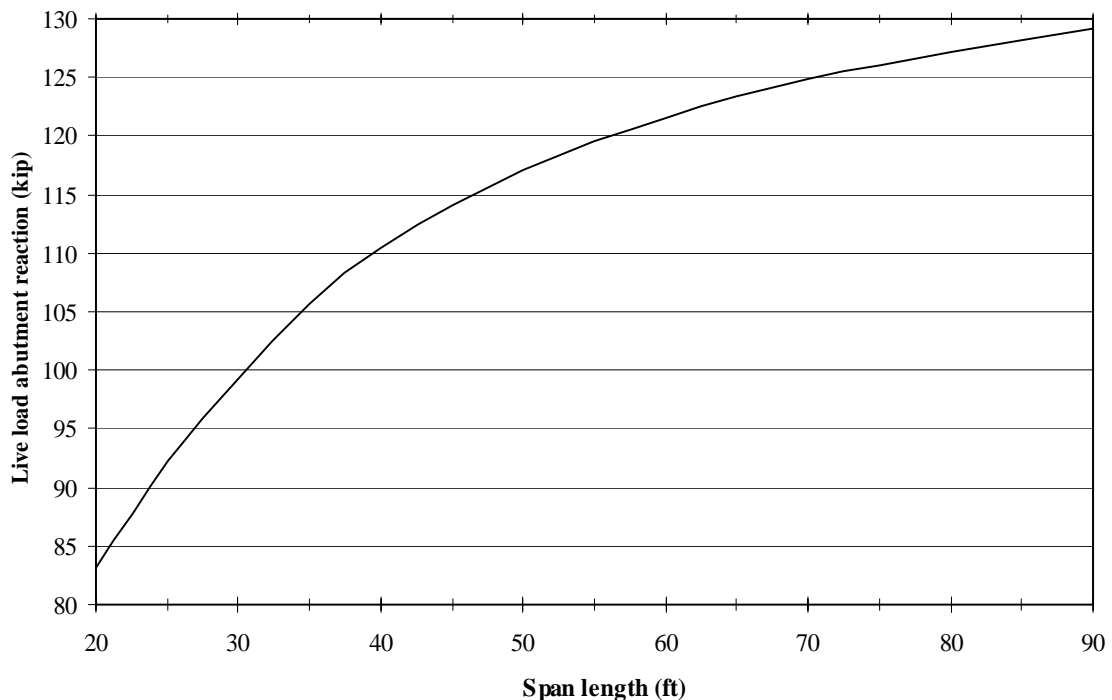

Figure 4.4. Maximum live load abutment reaction without impact for two, 10 ft design lanes.

number of 10 ft design lanes is equal to three, then 90 percent of the live load is applied. If four or more design lanes are used, then 75 percent of the live load is used. Live load impact is not included in the design of substructure elements embedded in soil (i.e., piles and the anchor system) as cited in Section 6.5 of the Iowa DOT Bridge Design Manual (Iowa DOT BDM) [8].

4.1.2. Lateral Loads

The substructure systems commonly used by Iowa counties are required to resist lateral as well as gravity loads. One type of lateral loading results from soil pressures acting on the substructure. Additional superstructure lateral forces are transmitted to the substructure through the bridge bearings.

The Iowa DOT defines two different horizontal soil pressures for bridge substructures as shown in Figure 4.5. The active soil pressure attributed to the permanent loading of the backfill soil is shown in Figure 4.5a. The magnitude of this soil pressure is determined as a function of backwall height, h , using Equation 4.1. The Iowa DOT BDM [8] cites values of 125 pcf and 33.7 degrees for the unit weight and friction angle, respectively.

The second Iowa DOT soil pressure distribution, presented in Figure 4.5b, is used to represent a live load on the approaching roadway. This live load is modeled as an equivalent soil surcharge equal to two feet with a unit weight of 125 pcf.

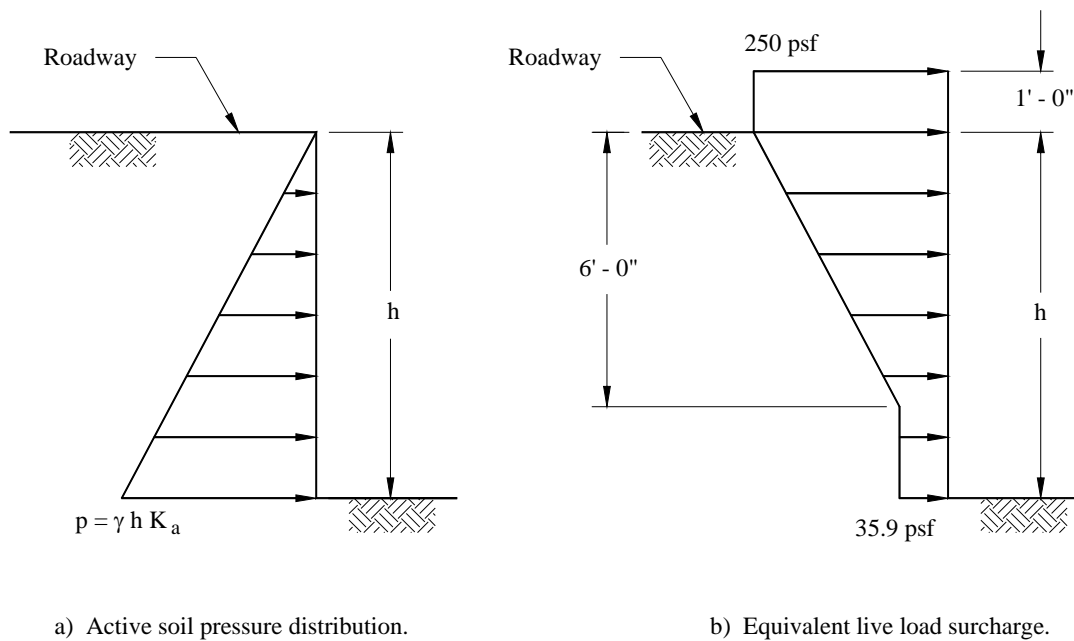

Figure 4.5. Lateral soil pressure distributions [adapted from the Iowa DOT BDM, 2004].

$$p = \gamma h K_a \quad (4.1)$$

where:

h = Backwall height.

$$K_a = \frac{1 - \sin \phi}{1 + \sin \phi} = \text{Rankine active earth pressure coefficient.}$$

p = Dead load active earth pressure.

ϕ = Soil friction angle.

γ = Soil unit weight.

As shown in Figure 4.5, the magnitudes of the lateral soil loadings are proportional to the backwall height. Scour on the streamside face of the backwall can wash away soil and effectively increase the backwall height; therefore an estimated depth of scour should be included if the geological and hydraulic conditions in the vicinity of the bridge site are conducive to this type of behavior.

Other lateral bridge loadings such as longitudinal and transverse wind forces in addition to a longitudinal braking force are also listed in the Iowa DOT BDM [8]. The longitudinal braking force is equal to five percent of the AASHTO [27] lane gravity loading multiplied by the number of 10 ft design lanes and does not include the multilane reduction factor previously discussed. One type of wind load consists of a 50 psf pressure that acts on the superstructure, roadway and barrier rail elevation surface area and acts perpendicular to the flow of traffic. A second wind load, also acting perpendicular to the flow of traffic, consists of a 100 plf line load that represents a wind force acting on the bridge live load. The load groups cited in Section 6.6 of the Iowa DOT BDM [8] are used to determine the maximum loading effects for the various combinations of gravity and lateral loadings.

4.2. STRUCTURAL ANALYSIS

Once the substructure loads have been defined, the structural analyses of the various systems can be performed to determine the internal element design forces. These forces include the pile axial load and bending moment, anchor rod forces, and the anchor block shear and bending moment. This step is denoted as Part B in Figure 4.1. Calculations which demonstrate the structural analysis techniques are presented in Volume 3 of this final report.

4.2.1. Internal Pile Forces

4.2.1.1. AXIAL PILE FORCE

As previously discussed, the abutment reaction is the sum of the dead and live load reactions which are used to determine the individual axial pile loads. The axial pile loads (i.e., the load each

pile must resist) are not only a function of the total number of piles but also their spacing and the location of superstructure reactions applied at the bearing locations. A nominal axial pile factor was developed to account for the non-uniform distribution of gravity loads to the piles due to the pile spacing and the location of the superstructure bearing points. Various combinations of superstructure systems and pile spacings were analyzed by creating a series of pile cap models and analyzing them using a structural analysis program. The pile cap was modeled as a continuous beam with the assumption of simple supports representing the piles. The loading consisted of point loads whose values were equal to the total abutment reaction divided by the number of superstructure bearing locations. Different combinations of pile and superstructure bearing location configurations produced various maximum axial pile forces within a given pile group. The maximum axial pile force for the more practical configurations were compared to the pile forces when the gravity loads were assumed to be evenly distributed to all piles. The nominal axial pile factors, shown in Table 4.1, were developed to account for axial pile loads for various superstructure systems and pile layouts. The design axial pile force is equal to the total abutment reaction divided by the number of piles times the nominal axial pile factor given in Table 4.1. Type 1 and Type 2 RRFC's refers to flat cars similar to those shown in Figures 1.3 and 1.4, respectively.

4.2.1.2. PILE BENDING MOMENT AND ANCHOR ROD FORCE

The lateral soil pressure distributions previously described are converted into distributed pile loads by multiplying the soil pressure by the pile spacing (i.e., tributary backwall area) to obtain a force per unit length. It is assumed that the longitudinal braking force and transverse wind loads are transferred to the piles at the bearing location. The total longitudinal braking force per abutment is divided by the number of piles to obtain a concentrated force for each pile. Additionally, the transverse wind loads are also resolved into a concentrated pile force that is applied at the top of the

Table 4.1. Nominal axial pile factors for various superstructure systems.

Superstructure System	Nominal Axial Pile Factor
PCDT	1.40
BISB	1.35
RRFC (Type 1)	1.20
RRFC (Type 2)	1.40
Prestressed girder	1.30
Slab bridge	1.00
Quad-tee	1.50
Glulam girder	1.40

pile to induce weak axis bending. The transverse wind on superstructure load per pile is calculated by multiplying the 50 psf wind pressure by half the span length and the superstructure elevation surface area, and then dividing by the number of piles. Similarly, the transverse wind on the bridge live load per pile is obtained by multiplying the 100 plf line load by half the span length and then dividing by the number of piles.

As previously noted in Chapter 3, two different lateral load analysis methods were used and compared. The linear method, presented by Broms [17, 18], produced comparable results to the non-linear computer analysis method. The linear method can be easily incorporated into a foundation design template; therefore it was selected for use in the design methodology for LVR bridge abutments. This allows the pile to be analyzed as a cantilever system.

The passive soil reactions for a single pile in both a cohesive and cohesionless soil resulting from external lateral loads are shown in Figures 3.7 and 3.8, respectively. The magnitude of this resistance depends on pile width parallel to the plane of bending and the properties of the soil. A uniform soil reaction is specified by Broms [17, 18] for cohesive soils, however no guidance on the exact shape of the soil reaction for cohesionless soils is provided. For the results presented herein, a parabolic shape was assumed. The total magnitude of the passive soil resistance equals the above ground lateral loadings.

For some cases, a lateral restraint system, consisting of a buried reinforced concrete anchor block tied to the piles by tension rods, can be used to reduce the lateral loading effects. Also, a positive connection between the superstructure and substructure uses the axial stiffness of the superstructure to transfer lateral loads among the substructures units.

If a lateral restraint system is not utilized, the maximum bending moment and deflection of the pile system is found using statics. The principle of superposition can be used to determine the combined effects of all the lateral pile loadings. The addition of a lateral restraint system creates a statically indeterminate system. Although there are several methods that can be used to solve this system, in this investigation an iterative, consistent deformation approach (in which the displacement of the lateral restraint system is equal to the displacement of the pile at the anchor location including the elongation of the anchor rod) was used. The two lateral restraint systems previously noted (a buried reinforced concrete anchor block and a positive bearing connection between the superstructure and substructure) were considered in this project.

To analyze each pile individually, the anchor rod axial stiffness per pile is calculated by equally distributing the total cross sectional area of all anchor rods for one abutment to each pile. In this case, an abutment wale as shown in Figures 3.1 and 3.2 must be provided so that the anchor rod

forces can be transferred to the adjacent piles. An abutment wale is not needed if an anchor rod is connected to each pile. After the anchor rod axial stiffness per pile is established, the structural analysis of the system is performed, using the iterative approach previously described, to determine the anchor rod force. Once this force is known, the maximum bending moment and deflection along the length of the pile can be determined.

4.2.2. Internal Anchor Block Forces

The anchor block is analyzed as a continuous beam using simple supports that correspond to the location of the anchor rods. The net soil reaction imparted on the anchor block to resist the lateral substructure loads is represented by a uniform distributed load equal to the anchor rod force per pile multiplied by the number of piles and divided by the total length of the anchor block. The moment distribution method was used to determine the moment at the anchor rod locations. Equilibrium equations are then used to determine the maximum internal shear and moment of the anchor block. Obviously, any structural analysis software packages could be used to determine the internal anchor block forces.

The support reactions obtained from the structural analysis will not necessarily be equal to the magnitude of the calculated anchor rod forces. The primary reason for this difference is the relative stiffness of the anchor block between the various anchor rods.

4.2.3. Miscellaneous Element Forces

The structural analysis of additional substructure elements such as the pile cap, abutment wale and backwall must also be performed. However, a design methodology for these additional elements is beyond the scope of this project.

The structural analysis of an abutment pile cap is similar to the process used in analyzing the anchor block that was previously discussed. The pile cap is modeled as a continuous beam with simple supports that correspond to the location of the piles. The total abutment reaction (including live load impact) is applied to the pile cap model as a series of concentrated forces that correspond to the superstructure bearing points. The magnitude of the concentrated forces are determined by either taking the total abutment reaction and dividing by the number of bearing points or using the tributary area above the superstructure bearing points. For a slab bridge, a uniform distributed load equal to the total abutment reaction divided by the length of the pile cap is used in place of the superstructure point loads. Any type of structural analysis for indeterminate structures can be used to determine the moments at the pile locations which in turn are used to determine the maximum internal shears and moments in the pile cap.

Backwall components are typically composed of horizontal timber planks, vertically driven sheet piles, or some type of precast or cast-in-place concrete panels (Figure 3.4). The magnitude of the backwall loads are determined by computing the soil pressures acting at a point of interest and then applying these pressures to the tributary area of the backwall section.

The abutment wale is analyzed as a continuous beam that spans between the supporting piles. There are two possible loading conditions for the abutment wale. If anchor rods are connected to the abutment wale, these rod forces are represented as point loads on the wale and act in the opposite direction of the backwall soil pressures. If the wale is located between the piles and backwall as shown in Figures 3.1 and 3.2, a uniformly distributed load that represents the total backwall load acting on a tributary area is applied to the abutment wale.

4.3. CAPACITY OF FOUNDATION ELEMENTS

The guidelines specified in AASHTO [27], the Iowa DOT BDM [8], and the National Design Specification Manual for Wood Construction (NDS Manual) [28] are considered in determining the capacities of the various foundation elements. This step in the design methodology is denoted as Part C in Figure 4.1.

4.3.1. Pile Capacity

4.3.1.1. BEARING CAPACITY

In the approach used herein, piles are classified into three groups, end bearing, friction bearing, and combined friction and end bearing piles. End bearing piles develop the necessary vertical capacity from the bearing of the pile tip on a relatively hard foundation material. Estimated end bearing values (in psi) for various H-pile sizes and foundation materials as stated by the Iowa DOT FSIC [19] are presented in Appendix B of Volume 2. These values are correlated to the SPT blow count and include a factor of safety of 2.0. The pile capacity is equal to the product of the cross sectional pile area and the estimated end bearing value.

Friction piles develop the necessary resistance from the shear forces between the embedded pile surface and the surrounding soil. The magnitude of this bearing resistance varies significantly with pile type and soil type. The Iowa DOT FSIC [19] also states estimated friction bearing values (in tons per foot) for various pile types and foundation materials. This information, which is correlated to the SPT blow count and includes a factor of safety of 2.0, is also included in Appendix B of Volume 2. The values provided for timber piles are based on a pile diameter of 10 in. If a different pile diameter is used, an appropriate friction bearing value per foot can be obtained by dividing the values provided by 10 in. and multiplying by the actual pile diameter in inches. For friction piles, the

bearing capacity is equal to the embedded pile length multiplied by the friction bearing value for the appropriate soil type.

The final pile bearing resistance category, friction and end bearing piles, combines the bearing components of the previous two bearing types. The total bearing value is equal to the sum of the end bearing and friction bearing resistances as previously described.

4.3.1.2. STRUCTURAL CAPACITY

4.3.1.2.1. Steel Piles

The Iowa DOT BDM [8] states that piles are to be designed using allowable stress design. All equations used for the design methodology of steel piles in this section are taken from Part C (Service Load Design Method) of AASHTO Section 10 [27]. Two interaction equations are used to compare the ratios of the applied stress to allowable stress for combined axial and bending loads. Equation 4.2 is one of these two requirements for steel piles subjected to combined loads. In all equations for this section, the x-axis and y-axis refer to the pile bending axis that are parallel and perpendicular to the backwall face, respectively. It is also assumed that for steel piles, the x and y-axis refer to the strong and weak bending axis of the pile, respectively.

$$\frac{f_a}{F_a} + \frac{C_{mx} f_{bx}}{\left(1 - \frac{f_a}{F'_{ex}}\right) F_b} + \frac{C_{my} f_{by}}{\left(1 - \frac{f_a}{F'_{ey}}\right) F_b} \leq 1.0 \quad (4.2)$$

where:

C_{mx} = Strong axis buckling coefficient.

C_{my} = Weak axis buckling coefficient.

F_a = Allowable axial stress.

f_a = Applied axial stress.

F_b = Allowable bending stress.

f_{bx} = Applied strong axis bending stress.

f_{by} = Applied weak axis bending stress.

F'_{ex} = Strong axis Euler buckling stress divided by a factor of safety.

F'_{ey} = Weak axis Euler buckling stress divided by a factor of safety.

The applied axial pile stress is equal to the axial pile load divided by the cross sectional area of the pile. The applied strong and weak axis bending stresses are determined by dividing the maximum longitudinal and transverse pile moments by the strong and weak axis section modulus,

respectively. The inverse of the two terms in parentheses in Equation 4.2 are the amplification factors that represent the secondary moments induced by the axial load and lateral deflection of the pile (P- Δ effect) [29]. For steel members subjected to both axial and transverse bending loads AASHTO [27] cites a value of 0.85 for the strong and weak axis buckling coefficients. The allowable bending stress is determined using Equation 4.3.

$$F_b = \frac{50 \times 10^6 C_b \left(\frac{I_{yc}}{\zeta} \right)}{S_{xc}} \sqrt{0.772 \left(\frac{J}{I_{yc}} \right) + 9.87 \left(\frac{d}{\zeta} \right)^2} \leq 0.55 F_y \quad (4.3)$$

where:

C_b = Bending coefficient (no units).

d = Pile depth (in.).

F_b = Allowable bending stress (psi).

F_y = Yield stress of steel in the pile (psi).

I_{yc} = Moment of inertia of the compression flange about the vertical axis in the plane of the web (in⁴).

J = Torsional constant (in⁴).

S_{xc} = Pile section modulus with respect to the compression flange (in³).

ζ = Length of unsupported flange between lateral support locations (in.).

The bending coefficient can be conservatively assigned a value of 1.0 for cantilever systems as cited by AASHTO [27]. For this design methodology, the unsupported flange length between support locations is equal to the distance between the point of pile fixity and the bearing location. This length is reduced if an abutment wale is attached to the piles. However this will only create a support for one flange, thus the abutment wale is not considered a lateral support.

If the largest slenderness ratio (defined below for both the strong and weak axis) is less than the column buckling coefficient given by Equation 4.4, then Equation 4.5 is used to determine the allowable axial pile stress. If the largest slenderness ratio is greater than the column buckling coefficient, then Equation 4.6 is used with the appropriate slenderness ratio to determine the allowable axial pile stress.

$$C_C = \sqrt{\frac{2\pi^2 E}{F_y}} \quad (4.4)$$

where:

C_C = Column buckling coefficient.

E = Modulus of elasticity.

F_y = Yield stress of steel in pile.

$$F_a = \frac{F_y}{2.12} \left[1 - \frac{(Kl/r)^2 F_y}{4\pi^2 E} \right] \quad (4.5)$$

where:

E = Modulus of elasticity.

F_a = Allowable axial stress.

F_y = Yield stress of steel in pile.

K = Effective length factor (see Table 4.2).

Kl/r = Slenderness ratio.

l = Pile length between braced points (see Table 4.2).

r = Radius of gyration.

$$F_a = \frac{\pi^2 E}{2.12 (Kl/r)^2} \quad (4.6)$$

where:

E = Modulus of elasticity.

F_a = Allowable axial stress.

K = Effective length factor (see Table 4.2).

Kl/r = Slenderness ratio.

l = Pile length between braced points (see Table 4.2).

r = Radius of gyration.

To calculate the allowable axial stress, the slenderness ratio used in Equations 4.5 and 4.6 is the maximum for either the strong or weak pile bending axis. A summary of the effective length factors and pile length between braced points to be used for the strong and weak axis with and without a lateral restraint system is presented in Table 4.2.

Table 4.2. Effective length factors and pile lengths between braced points.

	No Lateral Restraint System Used		Lateral Restraint System Used	
	Strong Axis	Weak Axis	Strong Axis	Weak Axis
K	2.0	0.7	0.7	0.7
Distance between braced points	Distance from point of fixity to roadway	Distance from point of fixity to bearings	Distance from point of fixity to lateral restraint location	Distance from point of fixity to bearings

The strong and weak axis Euler buckling stresses (F'_{ex} and F'_{ey}) used in Equation 4.2 are found by using the strong and weak axis slenderness ratios, respectively in Equation 4.6.

Equation 4.7 is the second requirement for steel piles subjected to both axial and bending loads.

$$\frac{f_a}{0.472 F_y} + \frac{f_{bx}}{F_{bx}} + \frac{f_{by}}{F_{by}} \leq 1.0 \quad (4.7)$$

where:

f_a = Applied axial stress.

F_{bx} = Allowable strong axis bending stress.

f_{bx} = Applied strong axis bending stress.

F_{by} = Allowable weak axis bending stress.

f_{by} = Applied weak axis bending stress.

F_y = Yield stress of steel in pile.

4.3.1.2.2. Timber Piles

Guidelines specified by AASHTO [27] and the NDS Manual [28] were used to develop the design methodology for timber piles. The material strengths of timber vary significantly with the type of species, member size, member shape, loading conditions and surrounding environmental conditions; timber modification factors are used to account for these variables. All equations and modification factors used in this section are described in detail in AASHTO, Section 13 [27]. Both AASHTO [27] and the NDS Manual [28] state that when necessary, round timber members can be treated as square members with an equivalent cross sectional area. Additionally, the diameter used to calculate the modification factors and the allowable stresses should be based on a representative cross sectional area of the pile. Since timber piles are tapered with the tip end being smaller than the butt end, a representative pile diameter is calculated using Equation 4.8 to account for the varying pile

cross section. Section 4165 of the Iowa DOT Standard Specifications [30] provides a table of minimum butt and tip diameters for timber piles.

$$d_{\text{rep}} = d_{\text{min}} + 0.33(d_{\text{max}} - d_{\text{min}}) \quad (4.8)$$

where:

d_{max} = Maximum pile diameter (i.e., the pile butt).

d_{min} = Minimum pile diameter (i.e., the pile tip).

d_{rep} = Representative pile diameter.

AASHTO [27] refers to Chapter 3 of the NDS Manual [28] for the design of timber piles subjected to both axial and bending loads. Equation 4.9 (from Section 3.9 of the NDS Manual [28]) is used for timber piles subjected to both bending and axial compressive loads. In this equation, the x-axis and y-axis refer to the pile bending axis that is parallel and perpendicular to the backwall face, respectively.

$$\left(\frac{f_C}{F'_C}\right)^2 + \frac{f_{bx}}{\left(1 - \frac{f_C}{F'_{ex}}\right)F'_{bx}} + \frac{f_{by}}{\left(1 - \frac{f_C}{F'_{ey}} - \left(\frac{f_{bx}}{F_{bE}}\right)^2\right)F'_{by}} \leq 1.0 \quad (4.9)$$

where:

F_{bE} = Bending buckling stress.

F'_{bx} = Allowable x-axis bending stress.

f_{bx} = Applied x-axis bending stress.

F'_{by} = Allowable y-axis bending stress.

f_{by} = Applied y-axis bending stress.

F'_C = Allowable compressive axial stress.

f_C = Applied compressive axial stress.

F'_{ex} = X-axis buckling stress.

F'_{ey} = Y-axis buckling stress.

The applied axial pile stress is equal to the axial pile load divided by the representative cross sectional area of the pile, and the applied x-axis and y-axis bending stresses are equal to the respective maximum pile moments divided by the section modulus. Since timber piles have a circular cross section, there is no difference between the x-axis and y-axis section properties. The allowable

compressive axial stress is determined using Equation 4.10. This equation involves a tabulated axial compressive stress and several modification factors. The tabulated axial compressive stresses provided by AASHTO [27] depend on the type of timber species and the structural grade. Section 4165 of the Iowa DOT Standard Specifications [30] states that all timber piles shall be creosote treated structural grade lumber either southern pine or douglas fir.

$$F'_C = F_C C_M C_D C_P \quad (4.10)$$

where:

C_D = Load duration factor.

C_M = Wet service factor.

C_P = Controlling column stability factor.

F'_C = Allowable compressive stress parallel to the grain.

F_C = Tabulated compressive stress parallel to the grain.

For this project, all load applications are considered to be permanent, thus a load duration factor of 0.90 is used. The wet service factors are classified by member size and species. For timber piles, a five inch square member or larger is used to obtain wet service factors of 1.0 and 0.91 for southern pine and douglas fir species, respectively. As shown in Equations 4.11 and 4.12, the column stability factor depends on the effective pile length previously described and presented in Table 4.2. The x-axis and y-axis correspond to the strong and weak axis values, respectively in Table 4.2 which for a circular element are obviously the same. The effective column length that yields the smaller column stability factor should be used in Equation 4.10.

$$C_P = \frac{1 + F'_e/F_C^*}{2c} - \sqrt{\frac{(1 + F'_e/F_C^*)^2}{(2c)^2} - \frac{F'_e/F_C^*}{c}} \quad (4.11)$$

where:

c = Member type adjustment factor.

C_P = Column stability factor.

F_C^* = Allowable compressive stress computed using Equation 4.10 without the column stability factor.

$$F'_e = \frac{K_{cE} E'}{(l_e/d)^2} \quad (4.12)$$

where:

- d = Equivalent square dimension.
- E' = Tabulated modulus of elasticity multiplied by the wet service factor.
- F'_e = Buckling stress.
- K_{cE} = Timber grading factor.
- l_e = Effective column length.

For visually graded, round timber piles, values of 0.85 and 0.30 are used for the member type adjustment factor and timber grading factor, respectively. The allowable bending stress is calculated using Equation 4.13. For this design methodology, the allowable bending stress for the x-axis and y-axes are equal.

$$F'_b = F_b C_M C_D C_L C_f \quad (4.13)$$

where:

- C_D = Load duration factor.
- C_f = Form factor.
- C_L = Beam stability factor.
- C_M = Wet service factor.
- F'_b = Allowable bending stress.
- F_b = Tabulated bending stress.

AASHTO [27] provides a list of tabulated unit bending stresses for various timber species and lumber grades. A wet service factor of 1.0 is used for all timber piles that have an equivalent cross sectional area greater than or equal to a five inch square member. As before, all load applications are considered to be permanent, thus a load duration factor of 0.90 is used. For timber members with a round cross section, a form factor equal to 1.18 is used. Finally, for members whose width does not exceed its depth, the beam stability factor is equal to 1.0.

Equations 4.14 and 4.15 are both used in the y-axis, secondary moment amplification (P-Δ) factor of Equation 4.9.

$$F_{bE} = \frac{K_{bE} E'}{R_B^2} \quad (4.14)$$

where:

E' = Tabulated modulus of elasticity multiplied by the bending wet service factor.

F_{bE} = Bending buckling stress.

K_{bE} = Timber grading factor.

R_B = Bending slenderness ratio.

$$R_B = \sqrt{\frac{l_e d}{b^2}} \quad (4.15)$$

where:

b = Member width.

d = Member depth.

l_e = Effective pile length.

R_B = Bending slenderness ratio.

The NDS Manual [28] cites a timber grading factor value of 0.439 for visually graded lumber. Since the bending buckling stress (F_{bE}) is compared to the applied x-axis bending stress in Equation 4.9, the effective pile length used to calculate the bending slenderness ratio in Equation 4.15 should also correspond to the pile x-axis. For round timber piles, the pile depth and width are equal to the equivalent square dimension previously discussed.

4.3.2. Anchor Block Capacity

In addition to the design of the piles, the capacity of the anchor block system must also be verified. This includes the determination of the anchor block structural capacity and the passive resistance of the surrounding soil. Variables such as the anchor rod force per pile, the elevation of the anchor system, anchor rod properties, and backwall width that were previously discussed are also required in determining the capacity of the anchor block.

4.3.2.1. LATERAL CAPACITY

The capacity of the soil surrounding the anchor block must be verified to ensure that it is capable of providing the necessary lateral resistance. The maximum efficiency of the anchor system is achieved when the anchor block is positioned beyond the passive and active soil zones as shown in Figure 4.6 [10].

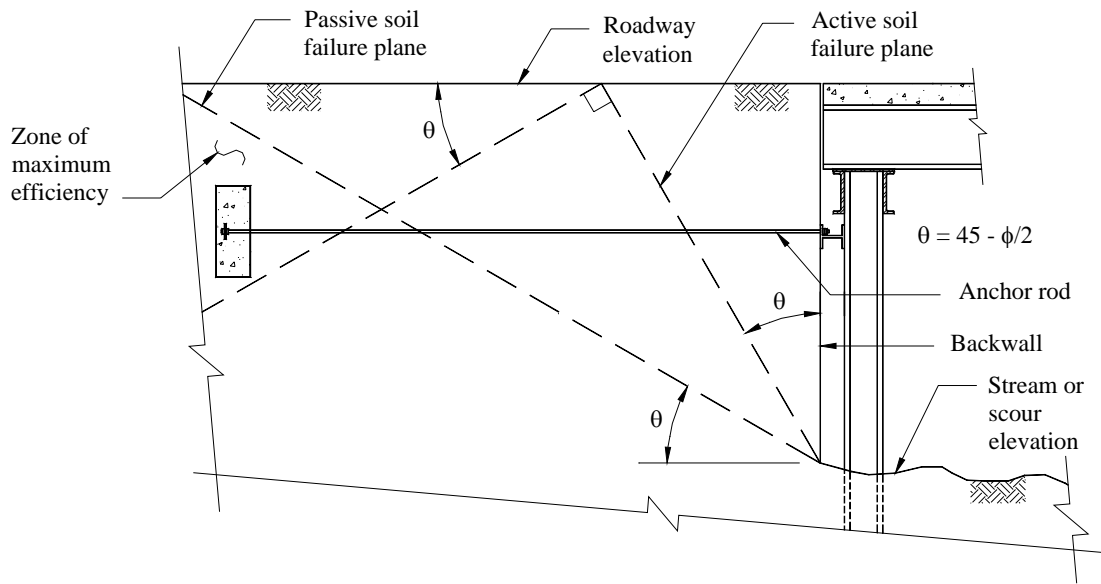

Figure 4.6. Location of anchor block for maximum efficiency [adapted from Bowles, 1996].

The anchor block system develops its lateral capacity from the mobilized soil pressures that acts on the vertical anchor block face as shown in Figure 4.7. The soil pressure distributions are a function of the surrounding soil properties and the depth of the anchor block with respect to the roadway surface. The magnitude of the maximum passive and active soil pressures acting on the anchor block face is based on the Rankine earth pressure theory which assumes that no shear forces exist between the vertical anchor block face and surrounding soil [10]. It should be noted that increasing the depth of the anchor block below the roadway will increase the lateral capacity, however this will reduce the anchor systems effectiveness in reducing the maximum pile moment. If an inclined anchor rod is used, the Coulomb theory, which accounts for shear forces on the anchor block face, should be utilized to determine the lateral capacity of the soil surrounding the anchor block.

The magnitude of the maximum lateral capacity is calculated using Equation 4.16. Bowles [10] recommends a factor of safety of 1.5 when calculating the soil resistance (not included in Equation 4.16). It should be noted that one must ensure that the backfill soil is carefully compacted around the anchor block so that the passive and active pressures can be fully mobilized [10]. The total lateral capacity of the anchor block system per pile is equal to the anchor resistance per foot (i.e., Equation 4.16) multiplied by the pile spacing.

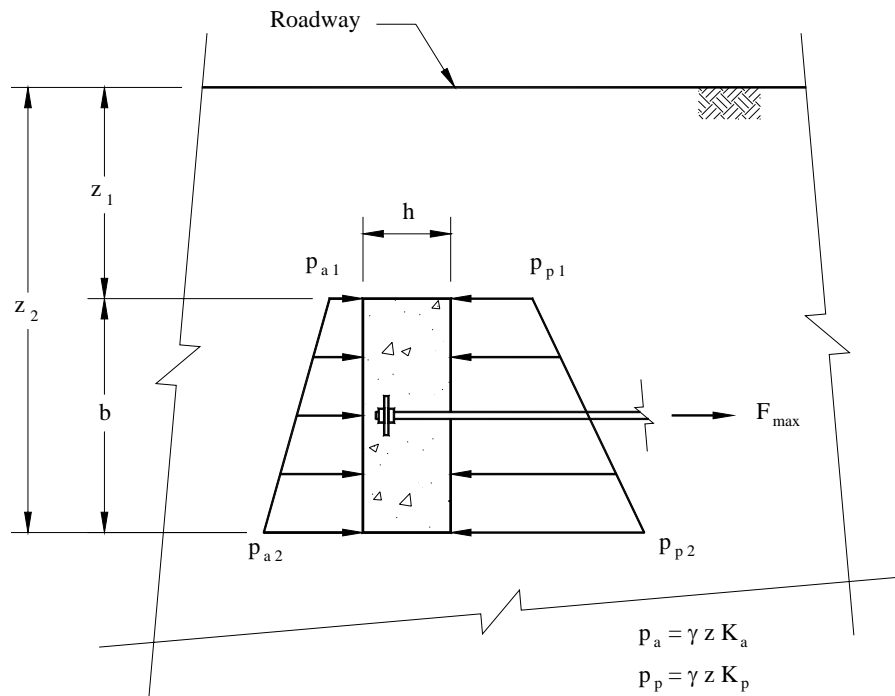

Figure 4.7. Soil pressure distribution used to determine the lateral anchor block capacity [adapted from Bowles, 1996].

$$F_{max} = \frac{\gamma b}{2} (z_1 + z_2) (K_p - K_a) \quad (4.16)$$

where:

b = Anchor block height.

F_{max} = Maximum lateral anchor block capacity (force per unit length).

$K_a = \frac{1 - \sin \phi}{1 + \sin \phi}$ = Rankine active earth pressure coefficient.

$K_p = \frac{1 + \sin \phi}{1 - \sin \phi}$ = Rankine passive earth pressure coefficient.

z_1 = Distance from roadway grade to the top of anchor block.

z_2 = Distance from roadway grade to the bottom of anchor block.

ϕ = Soil friction angle.

γ = Soil unit weight.

4.3.2.2. STRUCTURAL CAPACITY

Once the lateral capacity of the anchor block has been verified, the structural capacity must be investigated. The anchor block is designed using reinforced concrete design practice described in AASHTO, Section 8 [27]. This includes designing the flexural and shear reinforcement in addition to checking the development length requirements of the flexural reinforcement, the ductility, and the minimum reinforcement requirements. It should be noted that the internal anchor block bending loads induced by the anchor rods and soil pressure distributions act on a plane that is parallel to the backwall face. Therefore the effective depth of the concrete used in the flexure design is a function of the horizontal anchor block face dimension, 'h'. An example of the anchor block design process is included in a design verification example presented in Volume 3 of this final report.

4.3.3. Miscellaneous Substructure Elements

The capacity of additional substructure elements such as the pile cap, abutment wale, and backwall must also be determined. As previously mentioned, a design methodology for these additional elements is beyond the scope of this project.

A reinforced concrete pile cap would be designed using AASHTO [27] Section 8 whereas Section 10 would be used for the design of a steel pile cap. The structural capacity of the abutment wale and backwall system should also be determined using AASHTO [27] Section 10 and Section 13 for steel and timber materials, respectively.

4.4. DESIGN CHECKS OF FOUNDATION ELEMENTS

Once the internal element loads and capacities have been determined, the adequacy of the substructure system must be checked. In general, this consists of verifying that the system capacity is greater than the applied loads. This step in the design methodology for LVR bridge abutments is denoted as Part D in Figure 4.1. In the following sections, the specific design requirements for the pile and anchor system are presented.

The structural capacity of both steel and timber piles is not computed directly using the design methodology presented in this report; alternatively, interaction requirements are used to determine the ratios of applied to allowable stresses for combined bending and axial loadings. For steel piles, if Equation 4.2 or 4.7 yield a value less than 1.0, the pile is considered structurally adequate. This requirement is the same for timber piles, however Equation 4.9 is used. If the interaction equation requirement is not satisfied, an alternative substructure configuration must be used.

The pile bearing capacity must also be larger than the axial pile load. Additional bearing requirements are cited by AASHTO [27] and the Iowa DOT BDM [8]. Both sources state that the

maximum applied axial steel pile stress must not exceed 25 percent the steel yield stress.

Section 6.2.6 of the Iowa DOT BDM [8] provides more detailed axial pile stress requirements for both steel and timber piles based on the type of bearing resistance and the type of foundation material. The maximum allowable axial pile stress for a friction bearing steel pile is equal to 6 ksi. For end bearing steel piles, the maximum allowable axial pile stress is equal to 6 and 9 ksi for end bearing foundation material with a SPT blow count less than or greater than 200, respectively. Finally, the maximum axial pile stress for combined friction and end bearing steel piles is 9 ksi for an end bearing foundation material with a SPT blow count between 100 and 200. The maximum allowable axial pile stress is equal to 6 ksi for all other combinations of friction and end bearing foundation materials. For timber piles, the Iowa DOT BDM [8] states that the applied axial pile load must be less than 20 tons for pile lengths between 20 and 30 ft and 25 tons for pile lengths between 35 and 55 ft.

The capacity of the anchor system must also be verified. The applied anchor rod stress must be less than the allowable anchor rod stress defined in AASHTO [27] as 55 percent of the yield stress. The maximum passive resistance of the soil surrounding the anchor block (per foot of length) is obtained from Equation 4.16. This capacity per foot is multiplied by the pile spacing and must be greater than the required anchor force per pile as previously discussed. It is recommended that the total length of the anchor block be greater than or equal to the number of piles multiplied by the pile spacing. In order to satisfy the structural design requirements, the internal anchor block shear and bending forces resulting from applied loads must be less than the structural capacity of the anchor block determined using AASHTO [27] reinforced concrete guidelines.

5. ALTERNATIVE LOW-VOLUME ABUTMENT SYSTEMS

The literature search revealed several alternative abutment systems that may be of interest to Iowa Engineers. Each of these systems are well established in a particular geographic region or for a specific use, however none of them have been used as a bridge abutment system in Iowa. Alternative abutment systems include micropiles, geosynthetic reinforced soil (GRS) structures, Geopier foundations, and sheet pile abutments. Since these are economical and provide advantages over the traditional deep foundation systems currently used (i.e., driven piles), they show promise for numerous sites in Iowa. As noted in Chapter 7, it is proposed that several of these systems be tested in demonstration projects.

5.1. MICROPILES

Micropiles originated in Italy in the early 1950's and are used to strengthen and stabilize existing structure foundations. The term "micropile" is one of many terms used to describe a small diameter bored injection pile. Other terms include: minipile, root pile, pinpile, drilled-in-pier pile and drilled cast-in-place concrete pile [31, 32]. The term micropile will be used herein.

A micropile is typically defined as a small diameter (less than 12 in.) structural element that is constructed by boring a hole in the soil and filling it with steel reinforcement and either gravity flow or pressurized cementitious grout. The steel reinforcement typically consists of either steel reinforcement bars and/or a tubular drill casing left in place for the upper length of the micropile shaft. Micropile lengths of close to 100 ft with diameters ranging from 3.9 to 11.8 in. have been documented [31]. Depending on the soil conditions and pile size, a micropile can have a bearing capacity up to 225 kips. This relatively large capacity is developed from the frictional forces between the grout and the surrounding soil [33].

Significant micropile usage began in the United States in the late 1970's [32]. California is one of the leading states in the use of micropile foundations. Many existing foundations in the earthquake prone region require retrofitting to meet new seismic design code requirements. Micropiles have both substantial tensile and compressive capacities making them ideal for these situations. They can be easily incorporated in an existing structure by either drilling holes into the existing foundation or tying a new pile cap into the existing structure [34].

As previously noted, micropiles were originally developed to underpin or strengthen existing structure foundations in urban areas where excavation or driven piles were not feasible alternatives. Driven piles require more space and overhead clearance when compared to the minimum 8 ft

clearance required for the installation of some micropiles. Also, the excessive vibrations associated with driving piles can influence the surrounding soil and initiate additional settlement [32].

There are many situations when a micropile system could be more cost effective than driven piles. The equipment used for micropile installation is relatively small compared to pile driving equipment and is therefore more mobile. Micropiles are also ideally suited for fragile environmental areas since the installation equipment produces a relatively small amount of noise, vibrations, and waste material. Another advantage of micropiles is that they can be installed in situations in which traditional driven piles may not be practical. This includes the presence of compressible and expansive soil layers. Downdrag and uplift forces are not as influential on micropile foundations due to the relatively small surface area of the piles. Additionally, the presence of cobbles, boulders and other subsurface obstructions are not as troublesome for micropiles as they may be for driven piles [34].

Micropiles work well for many situations; however, there are some restrictions. The small diameter of micropiles limit their lateral load and flexural capacities. Alternatives include the use of a battered micropile to resist lateral loadings or replacing the bar reinforcement with structural steel tubing located on the upper length of the micropile shaft. Another restriction of micropiles is the special techniques required for installation, including various drilling techniques, reinforcement types, grout mixtures, and grout placement procedures. If a micropile is not properly designed for the site conditions, or if the contractor does not have sufficient experience with installing micropiles, the structural and bearing capacity of the micropile can be compromised [34].

Micropile installation procedures may require an experienced contractor, however the techniques and equipment required are generally no different from what is required for the installation of ground anchors, soil nails and grout holes. The general construction sequence for micropiles using a drill casing is shown in Figure 5.1. First, a hole is drilled to the appropriate depth. A drill casing is inserted into the hole to maintain the shape as the depth increases. Once the desired depth has been obtained, the drill bit is removed and the casing is left in place. Next, gravity flow grout is placed in the hole in addition to any steel reinforcement. Finally, the top of the drill casing is sealed and an additional amount of grout is placed under pressure while the drill casing is raised to the final height. The finished micropile is then tied to a new or existing structure foundation. The increased grout pressure will create a grout bulb with an increased surface area. Additionally, the lateral pressure increases the bearing capacity of the pile by improving the ground-to-ground bond. The drill casing can be left in place for the micropile reinforcement as shown in Figure 5.1 [34].

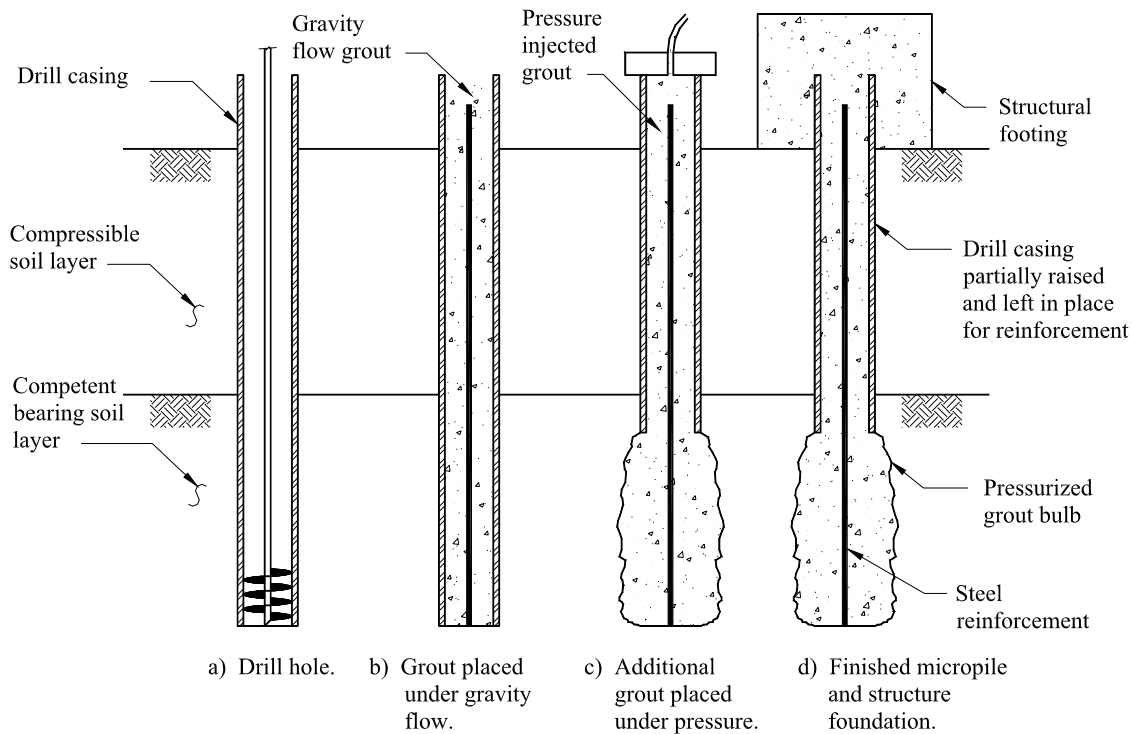

Figure 5.1. Micropile construction sequence [adapted from FHWA, 2002].

The design of a micropile includes several aspects of structural and geotechnical engineering. The bearing capacity of the pile, including friction and end bearing must be investigated. The FHWA publication; *Micropile Design and Construction Guideline* [34] includes a table of grout-to-ground bond design strengths for different soil and rock types. The structural design of micropiles typically controls for most situations since the cross sectional area of the micropile is relatively small. Also, the connection of the micropile to the structure must be investigated to ensure that the loads can be safely transferred to the micropile foundation [34].

The FHWA provides micropile foundation design examples for both service load design (SLD) and load factor design (LFD) approaches in accordance with AASHTO [27]. These examples include length and embedment calculations, bearing and structural capacity design checks, buckling and lateral load considerations, load factors, strength reduction factors, and serviceability limits. Currently, most geotechnical engineers use the SLD method, however engineers are changing to the LFD method and the new load resistance factor design (LFRD) [34].

5.2. GEOSYNTHETIC REINFORCED SOIL BRIDGE ABUTMENTS

A geosynthetic reinforced soil (GRS) bridge abutment is a retaining wall with layers of geosynthetic material attached to the front wall face that extends back between lifts of well-compacted backfill as shown in Figure 5.2. Typically, a shallow bridge spread footing rests directly

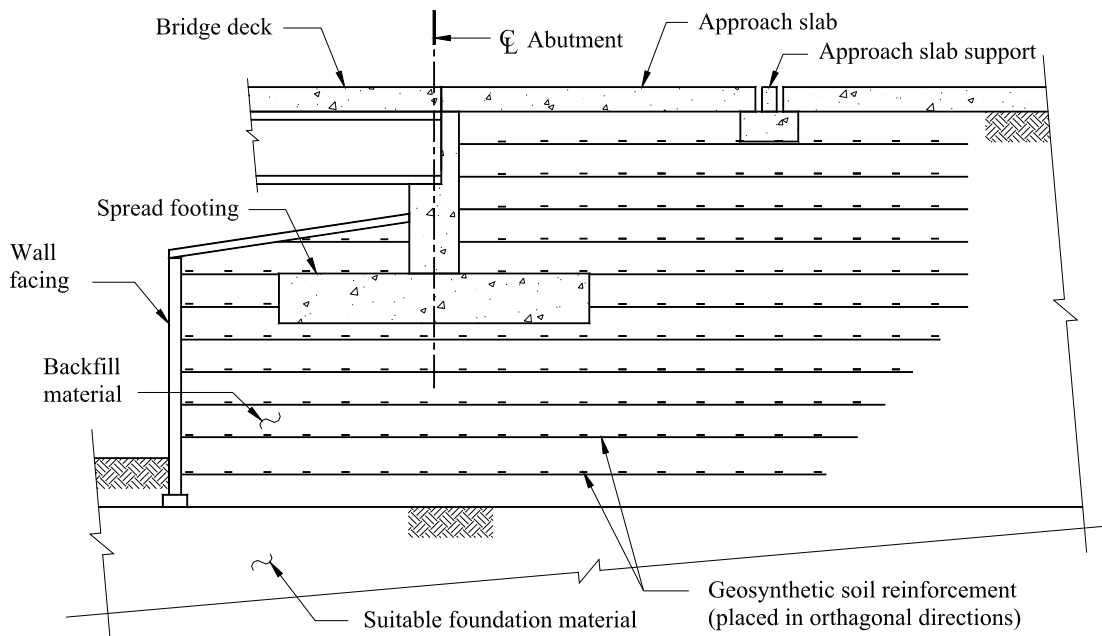

Figure 5.2. Cross-section of a GRS bridge abutment [adapted from Abu-Hejleh et al., 2000].

on the GRS mass several feet behind the wall face [35]. The wall facing consists of either rigid cast-in-place concrete, or a flexible material such as modular concrete blocks, timber planks, or gabions. Typical geosynthetic reinforcement consists of polymeric geosynthetic geotextiles or geogrids that are placed in orthogonal directions [36]. The foundation material below various GRS structures can range from bedrock to a fairly soft soil [37].

Various case histories have demonstrated the many advantages associated with a GRS bridge abutment. Some issues, such as aesthetics, do not significantly influence the design or cost. GRS bridge abutment wall facing blocks can be designed to be aesthetically pleasing to the public when compared to a cast-in-place reinforced concrete bridge abutment [35]. Most of the major advantages associated with a GRS bridge abutment relate to the potential cost savings. A GRS bridge abutment can be constructed in a relatively short time using light construction equipment and simple techniques. Heavy equipment such as cranes, drilling equipment, and pile driving machinery are not required. The only equipment required for their construction is a dump truck, front-end loader, compaction equipment, and a backhoe for excavation. The use of local labor and small equipment combined with a quick construction time generally results in a significant savings in construction costs [38].

Additional cost savings for a GRS bridge abutment can be realized by the reduction in differential settlement between the bridge and approaching roadway thus eliminating “the bump at the

end of the bridge”. Different settlement rates between the bridge foundation system (deep or shallow) and the approach roadway fill are typically the cause for this differential settlement. Past attempts to solve this problem have included extension of the wingwalls to further contain the backfill soil, using a stronger/stiffer approach slab, and using granular backfill soil to limit the magnitude of the settlement [35]. As shown in Figure 5.2, the geosynthetic reinforcement extends well beyond bridge abutment spread footing, thus the bridge foundation and approaching roadway are both supported by the same system. The additional approach slab support as shown in Figure 5.2 is to help reduce differential settlement in a GRS bridge abutment approach slab.

There are certain situations in which a GRS bridge abutment may not be a feasible alternative. For example, the front face of the GRS bridge abutment wall does not extend very far below the ground line. Therefore, the GRS mass should be placed on a coarse, non-scour susceptible material or should only be used in situations where the potential for scour does not exist [39]. Also, GRS bridge abutments can tolerate differential settlement thus exhibiting good seismic performance [35]. However, if the total settlement is projected to be more than three inches, deep foundation elements should be considered [39].

The Founders/Meadow bridge abutment in Colorado was the first GRS bridge abutment constructed in the United States for large volumes of traffic; this bridge was opened in 1999 [40]. Other GRS bridge abutments have been built by several different government agencies such as the FHWA, the Colorado DOT, as well as the California DOT (Caltrans), and Alaska DOT in conjunction with the United States Forest Service [37, 38, 40]. These GRS bridge abutments were for either small forest park roads, trail bridges, or for experimental purposes.

As previously described, the application of a GRS structure as a bridge foundation is a relatively new idea. Based on the performance of the experimental and in service GRS bridge abutments, some recommendations can be made. One important factor associated with a GRS bridge abutment is the condition of the backfill soil. The backfill material should consist of a coarse-grained soil with a high soil friction angle that is compacted with a 95 percent compactive effort [38, 41]. The Colorado DOT also recommends the construction of the backfill should take place in the drier, warmer months instead of the cold winter season. It may be possible that excess moisture could become trapped and freeze in the backfill soil during the winter months. When the temperature increases, thawing could create an outward wall displacement [39].

The geosynthetic reinforcement in a GRS mass increases significantly the vertical bearing capacity. It has been documented that the strength of the geosynthetic reinforcement is not as influential as the vertical spacing of the reinforcement. A smaller vertical reinforcement spacing

creates more shear interaction between adjacent layers of reinforcement. This smaller spacing also requires smaller soil backfill lifts which allows for better control of compaction [39]. It has also been stated that a smaller vertical spacing will increase the overall stiffness of the reinforced soil mass thus reducing the associated creep deformations [42]. One final design recommendation states an allowable footing bearing pressure of 3.1 ksf (converted from 150 kPa) for GRS bridge abutments similar to the Founders/Meadows site. If a smaller vertical reinforcement spacing is utilized, the allowable footing bearing pressure could be increased to 4.2 ksf (converted from 200 kPa) [38, 41].

Recently, researchers in Japan began using preloaded and prestressed GRS bridge supports. As shown in Figure 5.3, a preloaded and prestressed GRS structure is constructed with rigid reaction blocks, placed on the top and bottom of the GRS mass, that are connected with vertical tie rods. A hydraulic jacking system is used to tension the tie rods thus inducing compression in the GRS mass. A series of cyclic loadings are typically applied up to the final prestressing force. The cyclic loading, as well as the final prestressing force, increases the overall stiffness of the GRS mass thus creating a nearly elastic structure for normal service conditions. Preloading and prestressing can also help limit creep deformations from sustained vertical loads, the residual compression from cyclic service loading, and the vertical deflection from live loads [43].

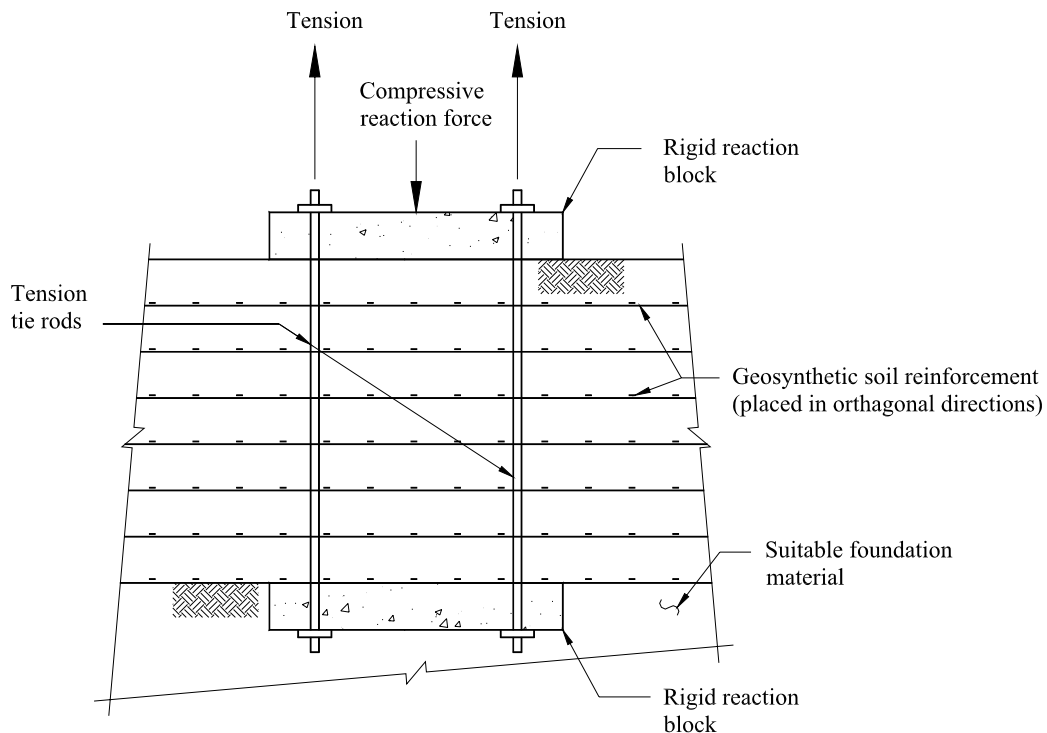

Figure 5.3. A preloaded and prestressed GRS structure [adapted from Uchimura et al., 1998].

The first preloaded and prestressed GRS bridge pier in Japan was put into service in 1997. In this initial project, a GRS bridge pier and abutment were constructed. The pier was preloaded and prestressed; the abutment was not preloaded and prestressed, which permitted a direct comparison of the two GRS systems to be made. The construction of the GRS bridge pier took five workers a total of five days to complete, and the duration of the preloading process took 72 hours. Structural monitoring under service loads has revealed that the preloaded and prestressed GRS bridge pier has behaved nearly elastically whereas the GRS bridge abutment had had a relatively larger residual compression. The Japanese researchers believe that the GRS bridge abutment will require premature maintenance work whereas the preloaded and prestressed GRS bridge pier will not [43].

5.3. GEOPIER FOUNDATIONS

Geopier foundations, or rammed aggregate piers, are a type of specially compacted aggregate columns that can be used to vertically reinforce a soil profile thus allowing a shallow spread footing foundation to be used in poor soil conditions. Geopier foundations are being used to control foundation settlement, provide uplift capacity, and to stabilize soil slopes. Geopier foundations are constructed using a unique technique that imparts lateral stress on the surrounding soil which increases the vertical bearing capacity and reduces the magnitude of total settlement [44]. Geopier elements are designed to improve the surrounding soil conditions; they do not support the foundation loads as independent structural members, therefore they do not need to extend to deeper, more suitable soil layers [45]. These advantages make Geopier foundations an effective and cost-competitive alternative. In certain situations, Geopier foundations result in a 40 to 60 percent cost savings when compared to deep foundations [44]. For example, Geopier foundations with lengths ranging from 7 to 9 ft in combination with shallow spread footings were used in the construction of a parking garage in place of 75 ft long driven piles at a cost savings of over 50 percent [46].

One of the biggest advantages of a Geopier foundation is that it can be used in poor soil conditions where settlement may be a concern. In these situations, typical foundation solutions include the excavation and replacement of existing weak soil layers or the driving of piles to bedrock. Typical Geopier foundations are less than 20 ft in length and have been documented to work in a variety of situations including soft organic clays, peat, loose silt, uncompacted fill soils, debris fill soils, stiff to very stiff clays, and medium dense to dense sands. Geopier foundations can increase the bearing capacity of weak soils so that the construction of a structure is feasible [46].

The Geopier foundation construction sequence is shown in Figure 5.4. The first step in the construction sequence involves drilling a hole 24 to 36 in. in diameter to a depth of 6 to 23 ft. A layer of crushed, clean aggregate is placed in the bottom of the hole and then compacted using a high-

energy, low frequency tamper. This causes the formation of an aggregate bulb at the base of the shaft that effectively increases the length of the Geopier element by about one shaft diameter. Finally, the shaft void is filled with 12 in. lifts of well-graded aggregate. A picture of the equipment typically used for the compaction process is shown in Figure 5.5 [47, 48].

The beveled shape of the high-energy hammer used in the construction of Geopiers forces the compacted aggregate lifts vertically and laterally against the shaft walls which improves the in-situ soil conditions by increasing the vertical and horizontal effective stress in the surrounding soil. This

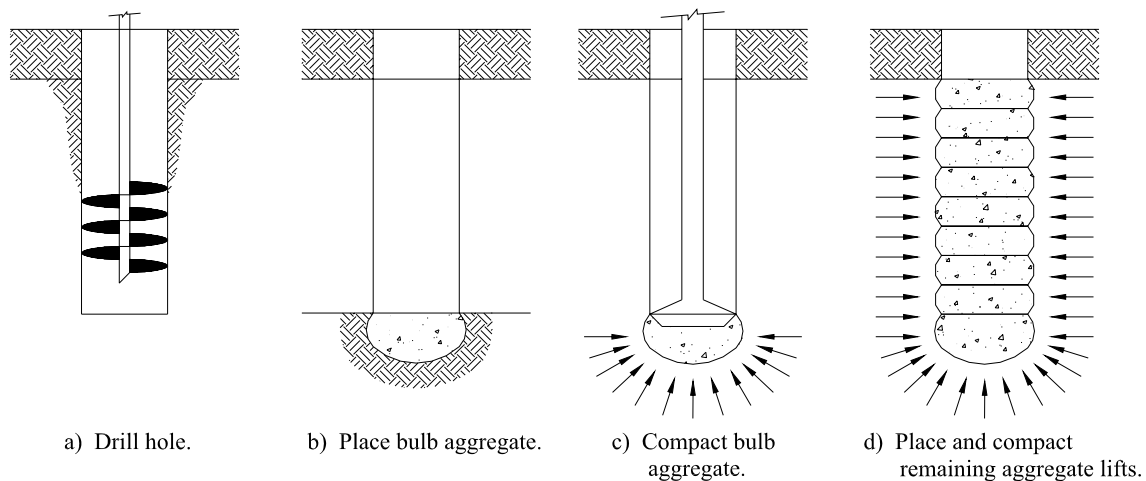

Figure 5.4. Geopier element construction sequence [adapted from Wissman et al., 2000].



Figure 5.5. High-energy, low-frequency hammer used for the construction of Geopier foundations [photo courtesy of the Iowa DOT].

increase in lateral soil stress corresponds to an increase in the soil stiffness. Thus, the soil profile behaves in a more elastic manner reducing both the immediate and long-term settlement. The vertical compactive effort also creates a stiffened column element that increases the overall average soil friction angle which correlates to an increase in bearing capacity [46, 47, 48].

Typically, Geopier foundations occupy about 30 to 40 percent of the foundation plan area and can increase the allowable soil bearing capacity between 5 and 9 ksf [48]. Geopier foundations can also be designed to provide an uplift capacity of up to 48 kips per element. For this situation, there is a direct connection between the Geopier element and the structure foundation as illustrated in Figure 5.6. Vertical tie rods are connected to a steel plate near the bottom of the Geopier element. The shear stresses that develop between the aggregate and the shaft wall from the compactive effort allows the Geopier element to behave as a high capacity friction pile. Tensile uplift tests have documented that a Geopier foundation behaves essentially elastically in silty sands. Tensile uplift tests conducted in clayey soils revealed plastic deformations of less than one inch [44].

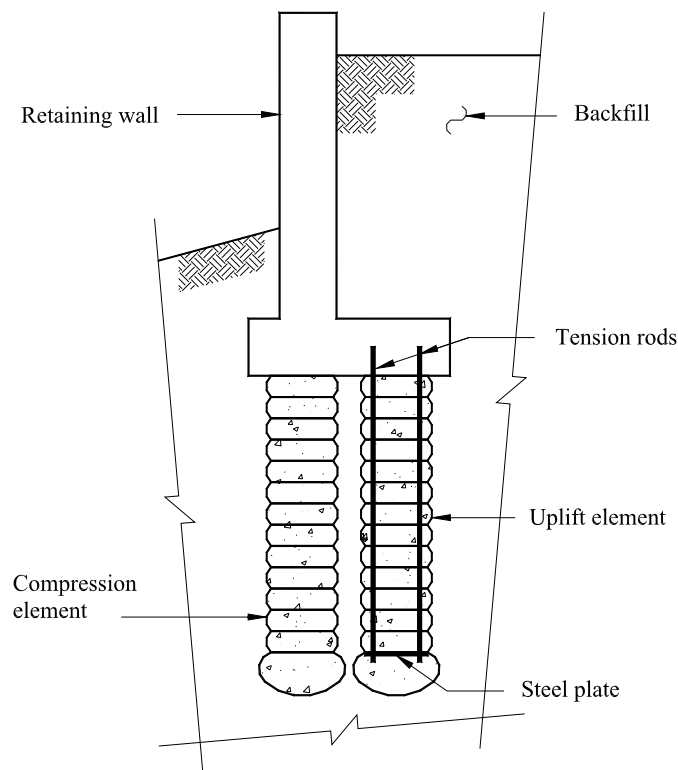

Figure 5.6. Retaining wall with Geopier uplift elements [adapted from White et al., 2001].

5.4. SHEET PILE ABUTMENTS

The use of sheet piles in the United States has traditionally been limited to retaining structures. However, bearing sheet piles have been used in Europe as the main foundation elements in road bridge abutments for over 50 years [49]. In the past decade, this system has seen increased use in the United States. Sheet piles not only have the capacity to resist the moment from lateral soil pressures, but also vertical gravity loads [50]. For typical LVR bridge abutments in Iowa, sheet piles are placed behind the foundation piles to act as a retaining wall. The use of a bearing sheet pile eliminates the need for separate backwall and the foundation piles. Details commonly associated with a sheet pile abutment are shown in Figure 5.7.

Another advantage of sheet pile abutments is the reduced construction time. Sheet piles do not require a significant amount of earthwork at the bridge site. For example, an earth embankment on the streamside face of the abutment is not required. The reduction in earthwork also reduces the amount of construction required. Since sheet pile abutments require less material they can be more cost-effective for LVR road bridges. Also a county could stockpile sheet pile sections instead of having to pay the additional costs associated with the transportation of concrete from a distant

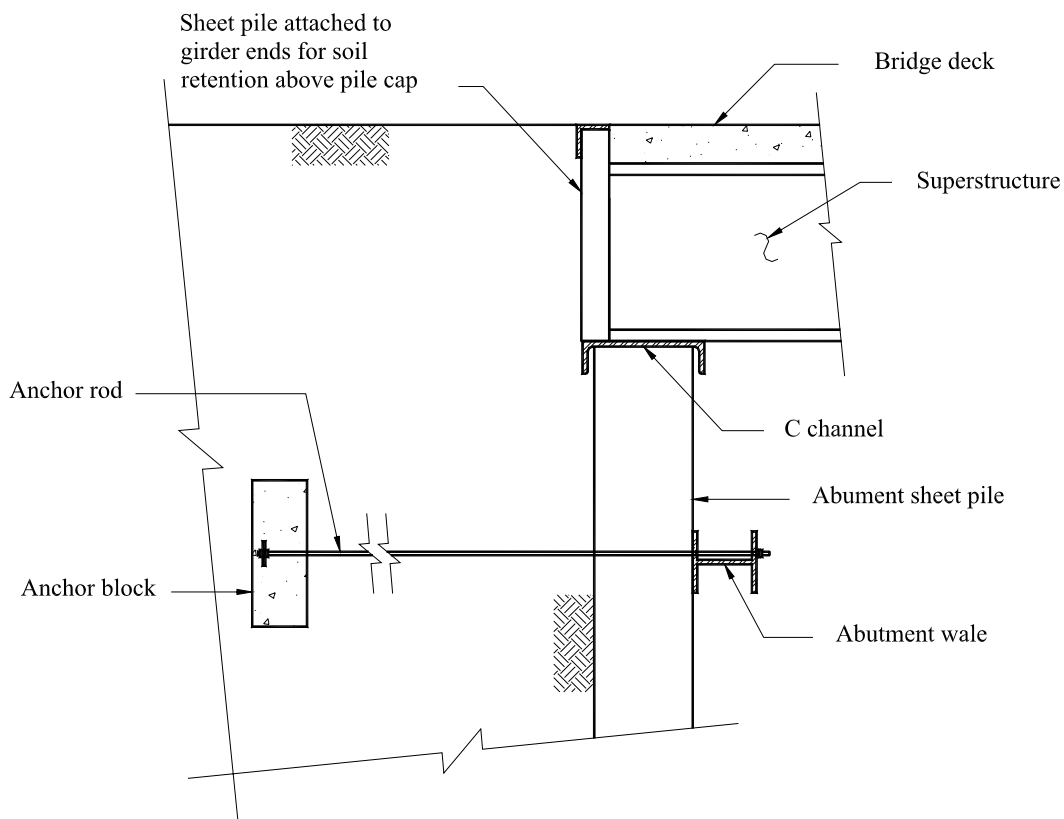

Figure 5.7. Cross-section view of a sheet pile abutment.

batch plant. Another benefit is the low-maintenance associated with a sheet pile abutment. For example, the sheet piles provide sufficient scour protection without any additional protective measures or regular maintenance requirements. The low-maintenance advantage in addition to the relatively simple construction makes it possible for county forces to easily install and maintain the abutments without external assistance [50].

In order to accurately estimate the horizontal sheet pile loads in addition to the lateral and bearing capacity, a detailed subsurface investigation, including soil borings and tests, should be performed. Once the foundation loads have been determined, the structural adequacy of a sheet pile section can be established. If a single row of sheet piles is not sufficient for the substructure, there are several alternatives. Box sheet piles, which are two u-shaped sheet piles placed back-to-back, can be used to create a series of pipe piles that are connected to the adjacent sheet piles to form the soil retaining structure as shown in Figure 5.8 [50]. These box piles will increase the cross-sectional area of the wall in addition to increasing the flexural capacity of the system. Also, a lateral restraint system can also be used to reduce the lateral load effects as previously discussed in Chapter 4.

In addition to the structural capacity of the sheet pile abutment, the lateral and bearing capacity of the soil must be verified. Bustamante and Gianceselli [51] provide basic design equations to determine both the end bearing and skin friction resistance for sheet piles in dense sands and plastic clays based on results from experimental tests. These design equations have been correlated to SPT, pressuremeter, and cone penetration test results.

Sheet pile abutments can be used in a variety of situations. In addition to stub abutments, sheet piles can also be used for integral abutments, which call for the use of a flexible foundation element. Sheet piles can accommodate the longitudinal thermal movements and the end rotation of

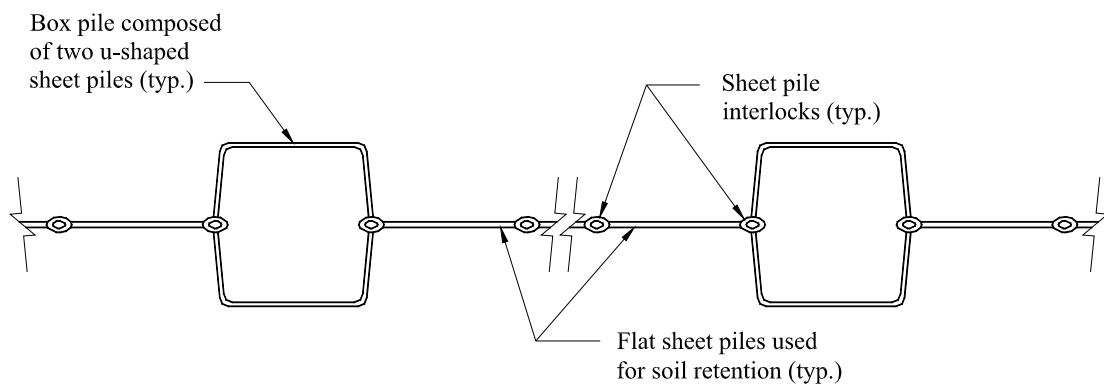

Figure 5.8. Plan view of a combination box and flat sheet pile abutment below the pile cap.

the superstructure caused by vehicle loads [49]. Sheet piles can also be used as the wall facing for a GRS bridge abutment thus providing the scour protection.

The Sprout Brook Bridge in Paramus, New Jersey highlights many of the advantages previously listed for a sheet pile abutment. The new 48 ft single span bridge was built in 1998 with a roadway width of 209 ft (13 traffic lanes). The original abutment design consisted of driven piles with a cast-in-place reinforced concrete pile cap built behind sheet pile cofferdams. An alternative substructure system was proposed by the consultant that included using sheet piles driven to bedrock as the main structural elements and an additional row of sheet piles for lateral support. This alternative design not only eliminated the need for cofferdams during construction, but also reduced the construction time by ten weeks and provided a savings of \$280,000. The reduced earthwork also eliminated four of the original six traffic phases. The sheet piles were designed for an axial load of 15 kip per ft and a maximum bending moment of 45 ft-kips per foot [49].

Another form of sheet pile abutments, an open cell sheet pile abutment, has been developed by a consulting firm in Alaska. As shown in Figure 5.9, a series of 15 in. flat sheet piles are driven in a semi-circular (or u-shaped) pattern with an approximate radius of 30 ft, which depends on the roadway width. The term open cell is used because the structure is not a closed circle as shown in Figure 5.9. The sheet piles do not need to be deeply embedded to obtain lateral stability, instead the back tail piles provide lateral support by acting as a friction anchor for the bearing piles directly below the superstructure. Installation and compaction of the backfill is also easier when compared to closed cells because equipment can be moved in and out of the structure without the use of a crane. Additionally, the rounded stream face allows for a larger flow area that correlates to a small span length and lower bridge costs [52].

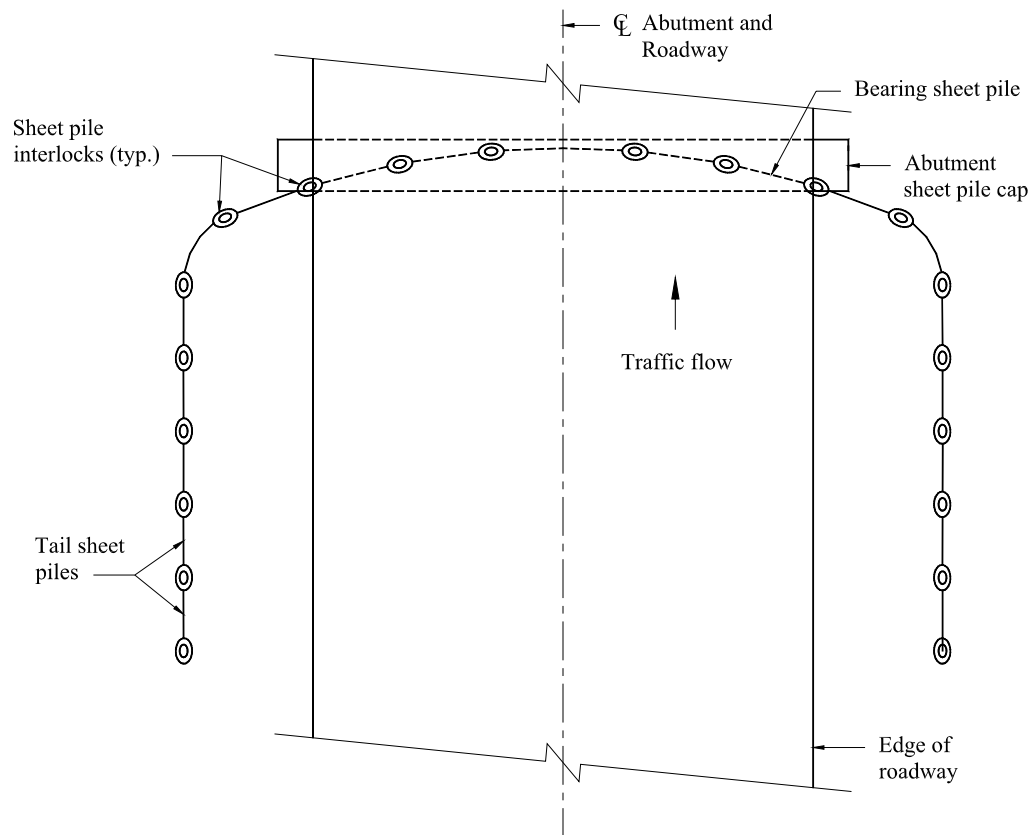

Figure 5.9. Plan view of an open cell sheet pile abutment [adapted from Nottingham et al., 2000].

6. REPORT SUMMARY

This research project consisted of three major phases: the collection of LVR bridge abutment information, the development of an abutment design methodology, and the creation of design aids for Iowa County Engineers and municipal engineers. In the first phase, a literature review and survey of the Iowa County Engineers was completed in addition to the formation of the PAC. The literature review focused on locating LVR bridge abutment design information. A survey was used to determine the level of current knowledge and/or use of standard design sheets by the counties and the identification of common construction methods and trends. The PAC, which was composed of Iowa County Engineers and representatives from the Iowa DOT Office of Bridges and Structures, provided information on the roadway and span length limitations, which superstructures should be accommodated by the standard abutment designs, information on backwall heights, and common pile materials. Additionally, members of the PAC noted that local Iowa Engineers would have more flexibility when designing an abutment if a flexible and easy to use design template was created (i.e., a spreadsheet or Visual Basic software). This phase of the project resulted in the identification of different LVR bridge abutment systems commonly used in Iowa counties, a series of alternative abutment systems, and two different pile analysis methodologies that could be used to investigate the influence of the lateral loading on the piles.

The literature search revealed several alternative abutment systems that are well established in a particular geographic region or for a specific use; however, none of them have been used in Iowa bridge abutments. The alternative abutment systems include micropiles, GRS structures, Geopier foundations, and sheet pile abutments. Since these are economical and provide advantages over the traditional deep foundations systems currently used (i.e., driven piles), they show promise for use in Iowa. As noted in the following chapter, it is proposed that several of these systems be investigated and tested in demonstration projects.

The second phase of this project involved investigating different lateral load analysis methodologies and the development of a foundation design methodology for the foundation elements. Two separate pile analysis methods were investigated, including a linear and a non-linear method. It was determined that each method has certain advantages such as the ability to model complex soil conditions and profiles, more accurately representing the actual soil and pile interaction, and the ease of incorporating the analysis method into a complete design methodology.

The maximum pile moments obtained from the linear and non-linear methods were compared; it was determined that the linear method is more conservative for most lateral load cases

associated with LVR bridge abutments. For stiff cohesive soils, the linear method is more conservative by 7 to 15 percent depending on the magnitude of the lateral pile loadings. However, the linear method produces less conservative maximum pile moments in soft cohesive soils. The linear method is less conservative by about 3 to 20 percent depending on the lateral pile loading. Finally, the maximum pile moments in cohesionless soils obtained from the linear method are more conservative by zero to three percent when compared to the non-linear analysis method.

Based on the relative simplicity and the correlation of the calculated maximum pile moments, it was decided that the linear analysis procedure presented by Broms [17, 18] would be the most suitable for this project. This method considers the pile fixed at a calculated depth below ground based on soil properties and lateral loading conditions. The maximum moment in the pile can then be calculated using basic structural analysis. The structural analysis procedure for the piles was developed using the recommendations of the AASTHO [27] and the NDS Manual for Wood Construction [28] for steel and timber piles.

An analysis and design methodology was also developed for the lateral restraint system that can be used to resist the lateral substructure loads. Two lateral restraint systems are presented: a positive connection between the superstructure bearings and the substructure, and a buried concrete anchor connected to the substructure with anchor rods. A positive connection between the superstructure bearings and substructure will transfer lateral loads between the superstructure units using the axial stiffness of the superstructure. The lateral restraint provided by an anchor system is a result of the passive soil pressure that acts on the vertical anchor face in the opposite direction of the lateral substructure loads as described by Bowles [10]. This lateral capacity is transferred to the pile system with the use of anchor rods and an abutment wale. The procedure for determining the structural capacity of the anchor block was developed using AASHTO [27] reinforced concrete design specifications.

The third and final phase of this project involved the development of the design aids that incorporate the previously mentioned design methodology. These design aids include a FDT with instructions and a series of generic standard abutment plans. The design spreadsheet is used to verify the adequacy of a pile and anchor system (if needed) for a particular bridge. The engineer inputs data such as bridge geometry, soil conditions, pile information, and lateral restraint details. This information is used in an analysis of the foundation system to determine the capacity of the system, and to complete the required design checks. Finally, a series of generic standard abutment plans were created for different situations. This includes different standard sheets for each combination of steel or timber piles either with or without concrete anchors, a steel channel or concrete pile cap, and a

backwall consisting of timber planks or vertically driven sheet piles. The standard abutment sheets can be used by Iowa County Engineers to produce the necessary drawings for the more common LVR bridge abutments systems. In order for the engineer to produce a finished set of abutment construction sheets, the necessary details such as the bridge geometry, member size (i.e., W, C, and HP shapes), and material properties must be provided by the engineer. Volume 2 of this final report is a design manual for LVR bridge abutments that also presents the previously mentioned design aids in detail. A series of design examples are also presented in Volume 3 of this final report.

7. RECOMMENDED RESEARCH

Additional research is recommended to investigate other types of abutments mentioned in this report. A brief description of several items that should be investigated is presented below:

- The literature search revealed several alternative abutment systems that could be economical at certain sites. These systems include micropiles, GRS structures, Geopier foundations, and sheet pile abutments. Some of these systems are well established in certain regions of the country or for a specific use; however, none have been used in a bridge abutment system in Iowa. Since these appear to be economical and provide advantages over the traditional deep foundations systems (i.e., driven piles), they show promise for use on Iowa LVR bridge abutments. Thus, demonstration projects employing each of these four systems should be undertaken. Each of these abutment systems should be instrumented and monitored for at least three years. Design methodologies and generic plans (similar to those developed in this project) should be developed to assist engineers with their design.
- The use of precast substructure elements for bridge abutments should be investigated. A precast system has several advantages. An offsite precast yard results in faster production and better quality control when compared to onsite concrete construction. Thus, precast elements will result in a faster construction sequence of a bridge's substructure. Additionally, once the casting elements have been purchased, the overall cost of future abutments will be reduced. Demonstration projects using precast elements will document these advantages. The details associated with the precast substructure elements noted below should be investigated:
 - Pile cap that can also be used as a backwall (similar to Figures 3.2 and 3.3).
 - Wingwalls.
 - Backwall panels that are placed between exposed steel H-piles (Figure 3.4).
 - Tieback systems (grouted in place).
 - Complete backwall systems that are post-tensioned to a system of piles.

- As previously noted, the design methodology and design aids developed in this investigation provide engineers with the tools to significantly reduce the time and effort required to design a LVR bridge abutment. Although the information and tools provided with this report can be applied to LVR bridge abutment design following the guidelines specified herein, a short course should be developed and administered to familiarize engineers with the design methodology and design aids. This one-half day short course could be presented in each of the six transportation districts to minimize travel time for Iowa County Engineers.

8. ACKNOWLEDGEMENTS

The research presented in this report was conducted by the Bridge Engineering Center under the auspices of the Engineering Research Institute of Iowa State University. The research was sponsored by the Highway Division of the Iowa Department of Transportation and the Iowa Highway Research Board under Research Project TR-486.

The authors wish to thank the various Iowa DOT Engineers and Iowa County Engineers who provided their input and support. In particular, we wish to thank the Project Advisory Committee:

Dean G. Bierwagen: Methods Engineer, Office of Bridges and Structures, Iowa DOT.

Brian Keierleber: County Engineer, Buchanan County.

Mark J. Nahra: County Engineer, Delaware County.

Tom P. Schoellen: Assistant County Engineer, Black Hawk County.

Special thanks are accorded to the following Iowa State University undergraduate civil engineering students for their assistance in various aspects of the project: Toshia Akers, Jonathan Greenlee, and Katie Hagen.

9. REFERENCES

1. Wipf, T.J., F.W. Klaiber, and A. Prabhakaran. *Evaluation of Bridge Replacement Alternatives for the County Bridge System*. Final Report for Iowa DOT HR-365, Aug. 1994, 113 p.
2. Wipf, T. J., F. W. Klaiber, and B. M. Phares. *Investigation of Two Bridges Alternating for Low Volume Roads – Concept 1: Steel Beam Precast Units*. Final Report for Iowa DOT HR-382: Volume 1 of 2, April 1997, 138 p.
3. Klaiber, F. W., T. J. Wipf, J. R. Reid, and M. J. Peterson. *Investigation of Two Bridge Alternatives for Low Volume Roads – Concept 2: Beam-In-Slab Bridge*. Final Report for Iowa DOT HR-382: Volume 2 of 2, April 1997, 140 p.
4. Klaiber, F. W., T. J. Wipf, and T. F. Konda. *Investigation of a Beam-in-Slab Bridge System for Low-Volume Road Bridges*. Final Report for Iowa DOT TR-467, publication expected Fall, 2004.
5. Wipf, T. J., F. W. Klaiber, J. D. Witt, and J. D. Doornink. *Demonstration Project using Railroad Flatcars for Low-Volume Road Bridges*. Final Report for Iowa DOT TR-444, February 2003, 193 p.
6. Abendroth, R., and L. Greimann. Rational Design Approach for Integral Abutment Bridge Piles. *Transportation Research Record*, No. 1223, pp. 12-23.
7. Iowa Department of Transportation. *H24S-87, HS30-87, H24-87, H30-87, J24-87, and J30-87 Standard Bridge Designs*. Ames: 1987.
8. Bridge Design Manual. Iowa Department of Transportation, Ames.
<http://www.dot.state.ia.us/bridge/index.htm> . Accessed August 30th, 2004.
9. Bridge Standard Drawings. Pennsylvania Department of Transportation, Harrisburg.
<http://www.dot.state.pa.us/Bridge/Standards/index.html> . Accessed August 30th, 2004.
10. Bowles, J. *Foundation Analysis and Design*, Fifth Ed. McGraw – Hill, New York, 1996.
11. Bridge Bureau 2003 Standard Drawings. Alabama Department of Transportation, Montgomery. <http://www.dot.state.al.us/Bureau/bridge/index.htm> . Accessed August 30th, 2004.
12. Bridge Detail (BD) Sheets. New York Department of Transportation, Albany.
http://www.dot.state.ny.us/structures/structures_home.html . Accessed August 30th, 2004.
13. Standard Bridge Drawings. Ohio Department of Transportation, Columbus.
<http://www.dot.state.oh.us/se/Default.asp>. Accessed August 30th, 2004.
14. Bridge Design Standards. Oklahoma Department of Transportation, Oklahoma City.
<http://www.okladot.state.ok.us/bridge/index.htm>. Accessed August 30th, 2004.

15. Bridge Standards. Texas Department of Transportation, Austin.
<http://www.dot.state.tx.us/business/standardplanfiles.htm>. Accessed August 30th, 2004.
16. Federal Highway Administration. *NCHRP Synthesis 32-08: Cost Effective Structures for Off-System Bridges*. Washington D.C: publication expected 2004.
17. Broms, B.B. Lateral Resistance of Piles in Cohesive Soils. *Journal of the Soil Mechanics and Foundations Division, Proceedings of the American Society of Civil Engineers*, Vol. 90, No. SM2, March 1964, pp. 27-63.
18. Broms, B.B. Lateral Resistance of Piles in Cohesionless Soils. *Journal of the Soil Mechanics and Foundations Division, Proceedings of the American Society of Civil Engineers*, Vol. 90, No. SM3, May 1964, pp. 123-156.
19. Iowa Department of Transportation. *Foundation Soils Information Chart*. Ames: 1994.
20. Terzaghi, K. and R. Peck. *Soil Mechanics in Engineering Practice*, Second Ed. Wiley, New York, 1968.
21. *LPILE Plus v. 4.0 for Windows Technical Manual*. ENSOFT, Inc., Austin, Texas, 2000.
22. Peck, R. B. *Foundation Engineering*. Wiley, New York, 1974.
23. USDA (United States Department of Agriculture), *Standard Plans for Timber Bridge Superstructures*, Washington, D.C., 2001.
24. Pretensioned, Prestressed Concrete Beam Standards: LXD Beam Details. Iowa Department of Transportation, Ames. <http://www.dot.state.ia.us/bridge/index.htm>. Accessed August 30th, 2004.
25. Wipf, T. J., F. W. Klaiber, B. M. Phares, and M.E. Fagen. *Investigation of Two Bridges Alternating for Low Volume Roads – Phase II, Concept 1: Steel Beam Precast Units*. Final Report for Iowa DOT TR-410: Volume 1 of 2, July 2000, 170 p.
26. Prestressed Concrete Quad Tee Bridge Standards. Cretex Concrete Products Midwest, Inc. (formerly known as Iowa Concrete Products Company), West Des Moines: 1991.
27. AASHTO (American Association of State Highway and Transportation Officials), *Standard Specifications for Highway Bridges, 16th edition*, Washington, D.C., 1996.
28. NDS (National Design Specifications), *Manual For Wood Construction*, Washington, D.C., 2001.
29. Breyer, D. E. *Design of Wood Structures*, Third Ed. McGraw – Hill, New York, 1993.
30. Iowa Department of Transportation, *Standard Specifications for Highway and Bridge Construction*, Ames, IA, 1997.

31. Bruce, D., and C. Yeung. A Review of Minipiling, With Particular Regard to Hong Kong Applications. *Hong Kong Engineer*, Vol. 12, No. 6, June 1984, pp. 31-54.
32. Bruce, D. Aspects of Minipiling Practice in the United States. *Ground Engineering*, November 1988, pp. 20-33.
33. Koreck, W. Small Diameter Bored Injection Piles. *Ground Engineering*, Vol. 11, No. 4, 1978, pp. 14-20.
34. FHWA (Federal Highway Administration), *Micropile Design and Construction Guidelines*, Publication No. FHWA-SA-97-070, Washington D.C., 2002.
35. Abu-Hejleh, N., and T. Wang, J. Zornberg. Performance of Geosynthetic-Reinforced Walls Supporting Bridge and Approaching Roadway Structures. *Geotechnical Special Publication*, Vol. 103, 2000, pp. 218-243.
36. Ashmawy, A., A. Cira, M. Gunaratne, and P. Lai. Factors Controlling the Internal Stability and Deformation of Geogrid Reinforced Bridge Abutments. *Transportation Research Board, 82nd Annual Meeting* (CD-ROM), No. 03-3201, 2003, pp. 1-17.
37. Keller, G., and S. Devin. Geosynthetic-Reinforced Soil Bridge Abutments. *Transportation Research Record*, No. 1819, 2003, pp. 362-368.
38. Adams, M., K. Ketchart, A. Ruckman, A. DiMillio, J. Wu, and R. Satyanarayana. Reinforced Soil for Bridge Support Applications on Low-Volume Roads. *Transportation Research Record*, No. 1652, 1999, pp. 150-160.
39. Abu-Hejleh, N., J. Zornberg, W. Outcalt, and M. McMullen. *Results and Recommendations of Forensic Investigation of Three Full-Scale GRS Abutment and Piers in Denver, Colorado*. Report No. CDOT-DTD-R-2001-6, Colorado Department of Transportation.
40. Abu-Hejleh, N., W. Outcalt, T. Wang, and J. Zornberg. *Performance of Geosynthetic-Reinforced Walls Supporting the Founders/Meadows Bridge and Approaching Roadway Structures – Report 1: Design, Materials, Construction, Instrumentation, and Preliminary Results*. Report No. CDOT-DTD-R-2000-5, Colorado Department of Transportation.
41. Abu-Hejleh, N., J. Zornberg, T. Wang, M. McMullen, and W. Outcalt. *Performance of Geosynthetic-Reinforced Walls Supporting the Founders/Meadows Bridge and Approaching Roadway Structures – Report 2: Assessment of the Performance and Design of the Front GRS Walls and Recommendations for Future GRS Abutments*. Report No. CDOT-DTD-R-2001-12, Colorado Department of Transportation.
42. Abu-Hejleh, N., J. Zornberg, T. Wang, and J. Watcharamonthein. Monitored Displacements of Unique Geosynthetic-Reinforced Soil Bridge Abutments. *Geosynthetics International*, Vol. 9, No. 1, 2002, pp. 71-95.
43. Uchimura, T., F. Tatsuoka, M. Tateyama, and T. Koga. Preloaded-Prestressed Geogrid-Reinforced Soil Bridge Pier. *6th International Conference on Geosynthetics Conference*, Vol. 2, March 1998, pp. 565-572.

44. Lawton, E., N. Fox, and R. Handy. Short Aggregate Piers Defeat Poor Soils. *Civil Engineering*, Vol. 64, No. 12, 1994, pp. 52-55.
45. Wissmann, K., and N. Fox. Design and Analysis of Short Aggregate Piers Used To Reinforce Soil for Foundation Support. *Proceedings, Geotechnical Colloquium, Technical University Darmstadt, Germany*, Vol. 1, No. 1, 2000, pp. 1-10.
46. Wissmann, K., N. Fox, and J. Martin. Rammed Aggregate Piers Defeat 75-Foot Long Driven Piles. *Geotechnical Special Publication*, Vol. 94, 2000, pp. 198-210.
47. White, D., K. Wissmann, and E. Lawton. Geopier Soil Reinforcement for Transportation Applications. *Geotechnical News*, Vol. 19, No. 4, 2001, pp. 63-68.
48. Wissmann, K., K. Moser, and M. Pando. Mitigating Settlement Risks in Residual Piedmont Soils With Rammed Aggregate Pier Elements. *Proceedings, ASCE Specialty Conference, Blacksburg, VA*, June 2001, pp. 1-15.
49. Carle, R., and S. Whitaker. Sheet Piling Bridge Abutments. *Deep Foundations Institute Annual Meeting, Baltimore, Maryland*, Oct. 1989, pp. 1-16.
50. Sassel, R. Fast Track Construction With Less Traffic Disruption. *Structural Engineer Magazine*, Oct. 2000, pp. 1-2.
51. Bustamante, M., and L. Gianceselli. Predicting the Bearing Capacity of Sheet Piles Under Vertical Load. *Proceedings of the 4th International Conference on Piling and Deep Foundations, Stresa Italy*, April 1991, pp. 1-8.
52. Nottingham, D., D. Thieman, and K. Braun. Design, Construction, and Performance of Open Cell Sheet Pile Bridge Abutments. *Proceedings of the Eleventh International Conference on Cold Regions Engineering: Impacts on Transportation and Infrastructure*, 2000, pp. 437-447.

APPENDIX A
TR-486 SURVEY

Iowa Department of Transportation
Highway Division
Research Project TR-486

“Development of Abutment Design
Standards for Local Bridge Designs”

Questionnaire completed by: _____

Organization: _____

Address: _____

E-mail address: _____

Responses can either be E-mailed or faxed to F. W. Klaiber (E-mail address: klaiber@iastate.edu; Fax number: 515-294-7424). If you have some abutment designs, pictures, etc. that you are willing to share, please mail them to:

Prof. F. Wayne Klaiber, P.E.
422 Town Engr. Bldg.
CCEE Dept.
Iowa State University
Ames, Iowa 50011

Section 1

Q-1) Does your county have standard bridge abutment designs that are used on low-volume road bridges or off-system bridges.

Yes _____ No _____

If you answered no to Q-1, please skip the remaining questions (Q-2 – Q-6) in this section and complete the questions in Section 2.

Q-2) Would you please send us a copy of your standard abutment design(s).

Yes _____ No _____

Q-3) In what situations (conditions) are your standard abutment designs not applicable?

Q-4) What is the maximum superstructure span length used with your abutment standards?

$L_{MAX} =$ _____

Q-5) What type of construction equipment, special tools, etc. are required to install your standard abutments? Please indicate after each item if you own the equipment (O) or rent the equipment (R).

Q-6) Approximately how long does it take to install one of your standard abutments? _____ hours. Approximately how many workers are required to construct a standard abutment? _____.

If you prefer, you can respond to Q-6 in man hours.

Section 2

Q-7) Do you know of other counties, cities, or other agencies that have standard abutment designs for low volume road bridges or off system bridges? If yes, please identify.

Q-8) Do you have a bridge construction crew that you routinely use to build small bridges or do you typically hire a contractor?

Q-9) Do you do a site investigation before installing substructures?

Yes _____ No _____

Q-10) If you do site investigations, what type (and number) of soil tests are completed?

Q-11) What types and how many foundation elements do you typically use in an abutment? How deep are they installed?

Comments?

APPENDIX B
TR-486 SURVEY SUMMARY

Table B.1. Summary of survey TR-486.

NOTE: NR means no response

Iowa DOT Transportation District	TR-486 Question						
	1	2	3	4	5	6	7
1	N	-	-	-	-	-	N
	N	-	-	-	-	-	N
	N	-	-	-	-	-	N
	N	-	-	-	-	-	Hardin and Jasper Counties
	N	-	-	-	-	-	N
	N	-	-	-	-	-	N
	N	-	-	-	-	-	N
2	N	-	-	-	-	-	N
	Y	Y	Not suitable when de-icing salts are used	40 ft	Crane, excavator, and sheet pile driver	96 man hours	N
	N	-	-	-	-	-	N
	N	-	-	-	-	-	Iowa DOT
	N	-	-	-	-	-	N
	N	-	-	-	-	-	N
	N	-	-	-	-	-	Iowa DOT
3	N	-	-	-	-	-	N
	N	-	-	-	-	-	N
	N	-	-	-	-	-	N
	N	-	-	-	-	-	N
	N	-	-	-	-	-	N
	N	-	-	-	-	-	Iowa DOT, Oden Enterprises
	N	-	-	-	-	-	N
	N	-	-	-	-	-	N
4	N	-	-	-	-	-	N
	N	-	-	-	-	-	N
	Y	Y	Works for most conditions	20 to 40 ft	Crane or dragline, grader, bulldozer, and welder	3 - 6 workers, 3 - 4 weeks	N
	N	-	-	-	-	-	N
	N	-	-	-	-	-	N
	Y	Y	Shallow limestone or bedrock	40 ft	Dragline, pile driver, and backhoe (all owned)	200 - 240 man hours	N
	Y	Y	NR	NR	NR	NR	N
	N	-	-	-	-	-	N
N	-	-	-	-	-	N	
Y	Y	Works for most situations	80 ft	Crane, pile driver, and sheet pile follow block (all owned)	160 man hours	N	

Table B.1. Continued

NOTE: NR means no response

Iowa DOT Transportation District	TR-486 Question (continued)			
	8	9	10	11
1	Contractor	Y	Soil borings.	NR
	Contractor	Y	Soil report for nearest location is used	Depends on bridge site
	Contractor	N	Old records are used to estimate pile depths.	Mostly timber piles are used, however concrete and HP's are also used
	Contractor	Y	Soil borings at each abutment.	Standard abutment designs are typically used with typical pile depths of 25 and 60 ft for timber and HP's respectively
	Contractor	NR	NR	NR
	Crew	N	-	NR
2	Contractor	Y	Four soil borings per bridge site.	HP's
	Contractor	Y	One soil boring per abutment.	HP10 X 42, and 14 in. square precast concrete piles, typically 30 to 60 ft deep
	Crew	Y	Soil borings to 60 ft (or auger refusal), SPT test, soil classification.	At least five HP10 X 42's depending on span length, skews angles, and backwall height
	Crew	Y	One soil test per abutment (if anything).	Stub abutments approximately three to four feet deep
	Contractor	Y	One soil boring per abutment, soil classification, SPT test.	Mainly use Iowa DOT abutment standards, concrete integral abutments with steel HP's driven to refusal
	Contractor	Y	At least one soil boring per abutment, SPT test.	HP's are driven to bedrock or precast concrete piles are driven to glacial till
	Crew	Y	One soil test per abutment (if anything).	Stub abutments approximately three to four feet deep
3	Contractor	Y	Depends on bridge geometry.	HP's driven to refusal and some timber friction piles, spread footings are rarely used
	Contractor	Y	Soil borings to at least 50 ft.	Concrete, steel, and timber piles typically 30 to 60 ft deep
	Contractor	Y	SPT test at each abutment.	Six to eight timber piles averaging 35 ft deep
	Crew	N	-	Five or six HP10 X 42's averaging 30 ft deep
	Contractor	Y	Soil borings.	Foundation work is not done in house
	Contractor	Y	Four soil borings per bridge.	Timber, HP's and concrete filled pipe piles typically 30 to 80 ft deep
	Contractor	N	-	Oden Enterprises and Iowa DOT standard abutments are used
	Contractor	Y	Two to four soil borings depending on the number of spans.	HP's typically 45 to 60 ft deep
4	Contractor	Y	Perform visual inspection or use soil borings.	HP depth determined by wave equation (blow count)
	Contractor	Y	SPT test at each abutment.	Six to eight timber piles typically 30 to 35 ft deep
	Both	N	-	Seven concrete filled pipe piles typically 20 ft deep
	Contractor	Y	Consultant performs site investigation and provides recommendations.	Depends on bridge site
	Crew	N	Foundation design based on other bridge sites in the area.	Five or six HP's typically 40 to 50 ft deep
	Contractor	Y	Up to six soil borings.	HP's driven to bedrock
	Crew	N	-	Five to seven HP10's or 12's are used
	Crew	Y	At least one soil boring per abutment.	HP10 X 42's and timber piles typically driven to bedrock
	Both	Y	Test pile is driven (if anything).	HP10 X 42's driven to bearing
	Both	Y	Soil borings for larger bridge sites.	Treated timber piles are used
Crew	N	-	Five to seven HP10 X 42's driven to refusal (typically about 60 ft deep)	
Crew	N	-	Five or six HP10 X 42's driven to a bearing of 17 to 20 tons	

Table B.1. Continued

NOTE: NR means no response

TR-486 Question (continued)	
Iowa DOT Transportation District	Comments
1	Estimating the pile depth from old records is cheaper than site investigation, bridges are designed by consultant
	Would like to see high concrete abutment standard, exposed timber piles are not recommended
	In favor of standard abutment designs
2	Would like to see a standard backwall that can be adapted for a different number of piles and span lengths
	The number of piles are determined by lateral and gravity loads.
	Standard drawings for high concrete abutments would be useful.
	Would like to see standard plans for an integral abutment for 24 and 30 ft roadway widths
	In favor of standard abutment designs
3	Mostly use Iowa DOT standards
	Standard abutment designs would be useful. Can try a precast concrete or sheet pile backwall.
	Oden Enterprise standard abutments are used, the ENR formula is used to determine bearing resistance
	Pile length is estimated using soil borings
	Typically uses Iowa DOT slab bridge standards, would like to see the creation of standard that are easier to build
Would like to see standard designs for high, stub, and fixed integral abutments. Does not recommend timber abutments	
4	
	Cass County does not have abutment standards but a common design theory is used
	In favor of standard abutment designs
	Formation of a bridge construction crew is in progress
	Construction and cost limitations require the use of a contractor
	In favor of standard abutment designs

Table B.1. Continued

NOTE: NR means no response

Iowa DOT Transportation District	TR-486 Question						
	1	2	3	4	5	6	7
5	N	-	-	-	-	-	Davis County
	Y	Y	shallow bedrock	70 ft	Crane, pile driver, welder, and excavator (all owned)	120 man hours	Oden Enterprises
	N	-	-	-	-	-	N
	N	-	-	-	-	-	Warren County
	N	-	-	-	-	-	N
	N	-	-	-	-	-	Lucas County
	N	-	-	-	-	-	Guthrie County
	N	-	-	-	-	-	Davis County
	N	-	-	-	-	-	Decatur County
	N	-	-	-	-	-	N
6	Y	-	Not suitable when span length is increased	40 ft	Crane and pile driver	4 laborers	N
	N	-	-	-	-	-	N
	Y	Y	Skewed bridges, multiple spans	56 ft	Dragline or pile driver (owned)	72 man hours	Scott County

Table B.1. Continued

NOTE: NR means no response

Iowa DOT Transportation District	TR-486 Question (continued)			
	8	9	10	11
5	Contractor	N	-	HP10 X 42's typically 40 or 50 ft deep
	Crew	N	-	Seven HP 10 X 42's originally 40 ft in length and spliced if needed
	Contractor	N	-	Only HP standard plans are used
	Contractor	N	-	Timber piles typically 20 to 40 ft deep
	Contractor	Y	One soil test per abutment.	Mostly timber piles are used, however HP's are also used
	Contractor	N	-	HP10 x 42's driven to a bearing of at least 25 tons
	Contractor	Y	One soil boring per abutment, SPT test.	Timber and HP's of varying depth
	Contractor	N	-	HP10 X 42's typically about 40 to 50 ft deep
	Contractor	N	-	HP's driven to bedrock with a large range in depth
	Contractor	Y	Soil borings.	Five to nine piles typically 30 to 90 ft deep
6	Both	NR	NR	Four or five HP10 X 42's averaging 35 ft deep
	Crew	N	-	Five or six timber piles typically 35 ft deep
	Crew	N	-	Eight to ten inch diameter timber piles typically 35 ft deep

Table B.1. Continued

NOTE: NR means no response

TR-486 Question (continued)	
Iowa DOT Transportation District	Comments
5	In favor of standard abutment designs
	In favor of standard abutment designs
	Knows standard abutment plans exists but does not know who created them
	Approximately 14 years ago, Guthrie County had standard abutment designs
	In favor of standard abutment designs
	Mostly use Iowa DOT standards
6	In favor of standard abutment designs
	In favor of standard abutment designs